

PHIXWELL

TOOLS PROFESSIONAL

NEW
S 2026
LAUNCH!

PHIXWELL



ADD:108 Sizha Road, Yangshe Town, Zhangjiagang City, Jiangsu Province, China

TEL:0086-512-58199000/0086-18658800788

WWW.XWTTOOLKIT.EN.ALIBABA.COM

WWW.PHIXWELLPRO.COM

ABOUT US

The company was established in 2014 and is located in Zhangjiagang City, Jiangsu Province. We have 10 automatic production lines. Annual output of tool sets is two million. We produce but not limited to hand tool sets, power tool sets, garden tool sets, wrenches and tool cabinets. Our products cover the Western European market, North American market, Russian market, South American market and Mexican market etc.







Tool cabinet production factory—Shentai, subsidiary of Xingwotai, covers an area of 30000 square meters and has over 50 production and processing equipment. We can achieve a monthly production target of over 10000 tool cabinets. Our cabinets are popular in major markets around the world.

We have global sales channels serving directly for large hardware and auto parts chain supermarkets, as well as various industrial users worldwide. And we are partner of many professional tool brands. At the same time, relying on domestic and foreign e-commerce platforms, we've provided diversified and high-quality products to global end users.

We'll continue to focus on our main business, adhering to the core concept of "customer first, keep improving, teamwork, innovation and mutual win", and commit to become a global well-known enterprise in tool industry to provide customers with better services.

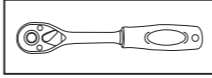
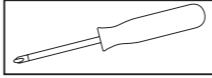
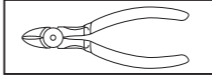

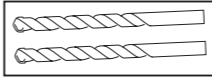
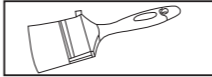
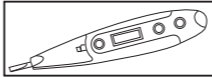
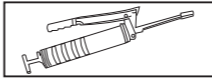
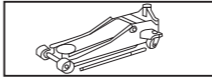
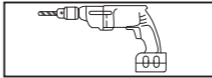
22 CATEGORIES CONTENTS

- | | |
|---|--------------------------------------|
|  | 01 TOOL CABINET |
|  | 02 TOOLS SET |
|  | 03 TOOLS BOX TOOLS BAG TOOLS CABINET |
|  | 04 SOCKETS & ACCESSORIES |
|  | 05 SPANNER TOOLS |
|  | 06 FASTENING TOOLS |
|  | 07 PLIER & CLAMPING TOOLS |
|  | 08 CUTTING TOOLS |
|  | 09 MEASURE TOOLS |
|  | 10 STRIKING TOOLS |
|  | 11 PLUMBING TOOLS |
|  | 12 TRIMMING TOOLS |
|  | 13 DECORATION TOOLS |
|  | 14 GARDEN TOOLS |
|  | 15 ELECTRONIC TOOLS |
|  | 16 AUTO TOOLS |
|  | 17 AIR TOOLS |
|  | 18 HYDRAULIC TOOLS |
|  | 19 POWER TOOLS |
|  | 20 WELDING TOOLS |
|  | 21 SAFETY TOOLS |
|  | 22 INSULATED TOOLS |

171 PCS DRAWERS TOOL CABINET

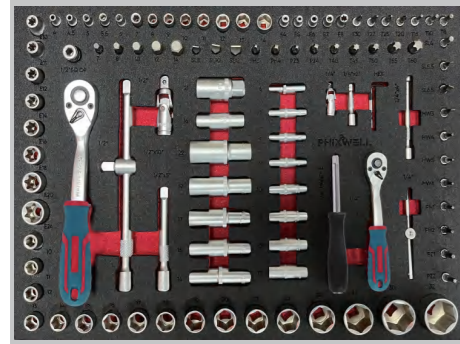

107PCS



9PCS



30PCS

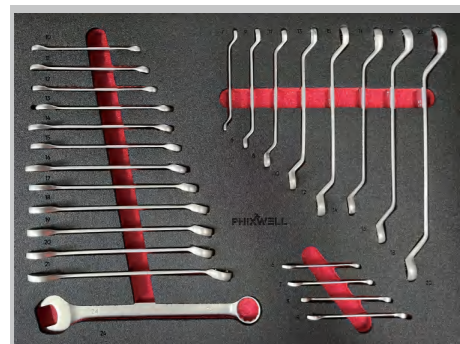

25PCS



ITEM NO.	719501
PACKAGE SIZE	780X490X770 MM
N.W./G.W.	67 /70 KGS
EMPTY G.W.	46 KGS
1X40 HQ	216 SETS

256 PCS TOOL CABINET

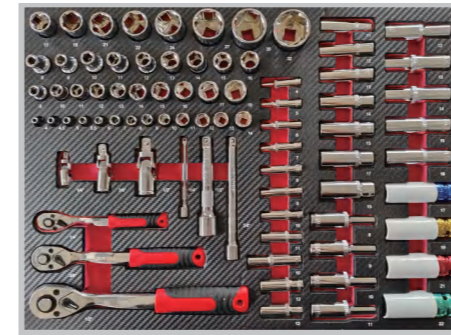

80PCS



102PCS



13PCS



8PCS



21PCS



ITEM NO.	719502
PACKAGE SIZE	790X500X770 MM
N.W./G.W.	60/64 KGS
EMPTY G.W.	46 KGS
1X40 HQ	207 SETS

249 PCS DRAWERS TOOL CABINET

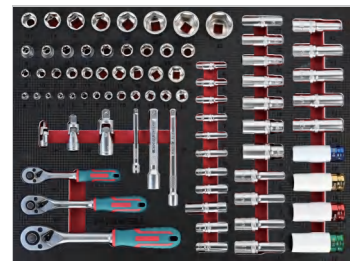

80PCS

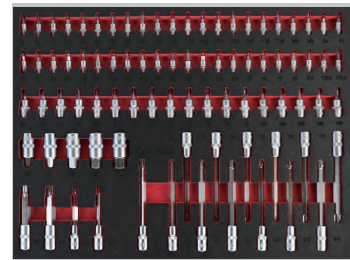

102PCS



14PCS



16PCS



21PCS

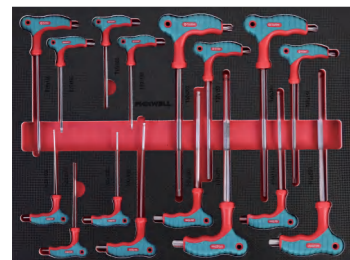

16PCS

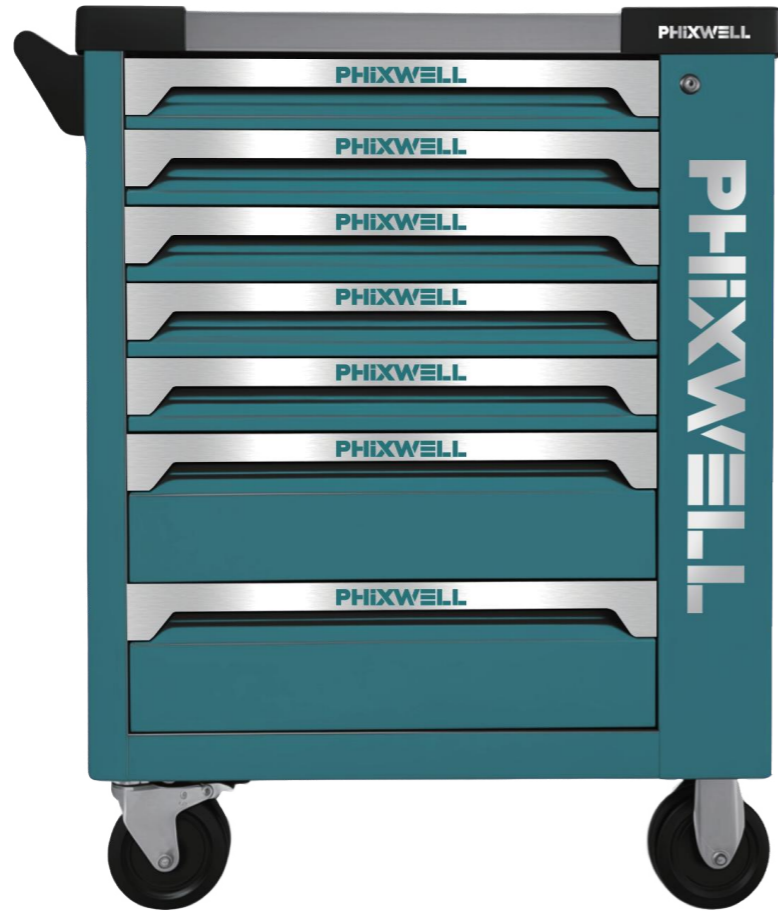

ITEM NO.	719503
PACKAGE SIZE	780X485X840 MM
N.W./G.W.	72 /76 KGS
EMPTY G.W.	54 KGS
1X40 HQ	216 SETS

256 PCS TOOL CABINET

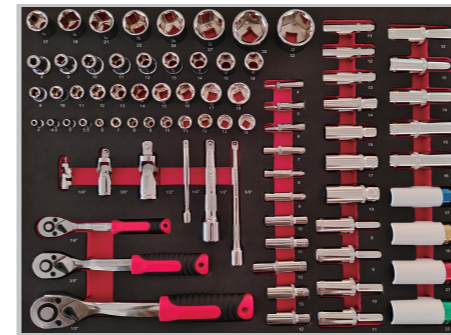

80PCS

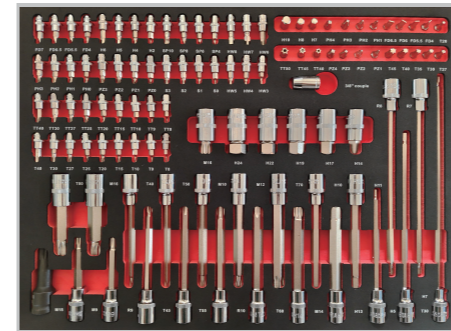

102PCS



16PCS



13PCS



21PCS



ITEM NO.	719504
PACKAGE SIZE	780X485X840 MM
N.W./G.W.	70 /74 KGS
EMPTY G.W.	50 KGS
1X40 HQ	216 SETS



16PCS



8PCS

249 PCS TOOL CABINET

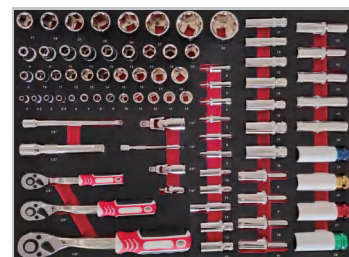

80PCS

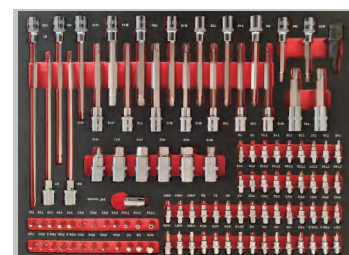

102PCS



14PCS



16PCS



21PCS



16PCS



ITEM NO.	719505
PACKAGE SIZE	790X490X870 MM
N.W./G.W.	72 /76 KGS
EMPTY G.W.	52.5 KGS
1X40 HQ	203 SETS

254 PCS TOOL CABINET



80PCS

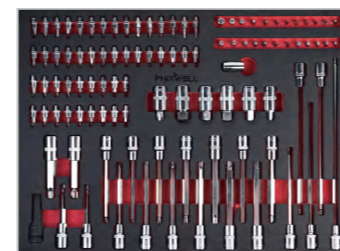

102PCS



21PCS



12PCS



25PCS

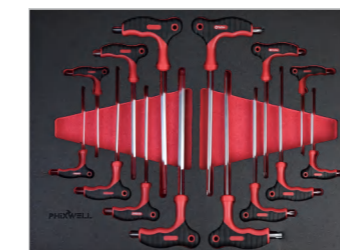

14PCS



ITEM NO.	719506
PACKAGE SIZE	720X495X840 MM
N.W./G.W.	72 /76 KGS
EMPTY G.W.	55 KGS
1X40 HQ	216 SETS

249 PCS TOOL CABINET



80PCS

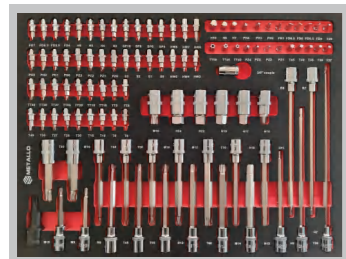

102PCS



14PCS



16PCS



21PCS



16PCS



ITEM NO.	719507
PACKAGE SIZE	785X485X840 MM
N.W./G.W.	75 /78 KGS
EMPTY G.W.	56 KGS
1X40 HQ	216 SETS

243 PCS TOOL CABINET



80PCS

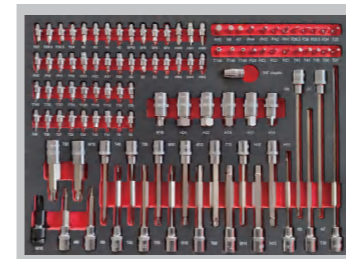

102PCS



14PCS



16PCS



10PCS



21PCS



ITEM NO.	719508
PACKAGE SIZE	730X490X900 MM
N.W./G.W.	72 /75 KGS
EMPTY G.W.	53 KGS
1X40 HQ	196 SETS

307 PCS TOOL CABINET

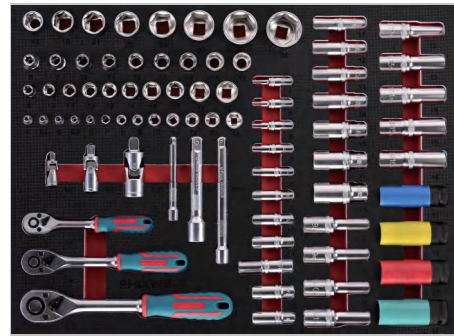

80PCS

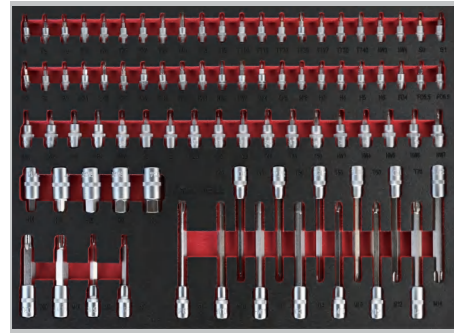

102PCS



21PCS

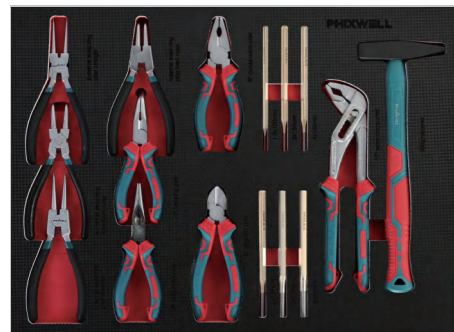

16PCS

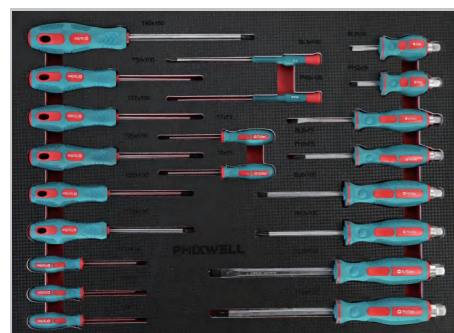

21PCS



ITEM NO.	719509
PACKAGE SIZE	910X490X850 MM
N.W./G.W.	82 /86 KGS
EMPTY G.W.	60 KGS
1X40 HQ	183 SETS

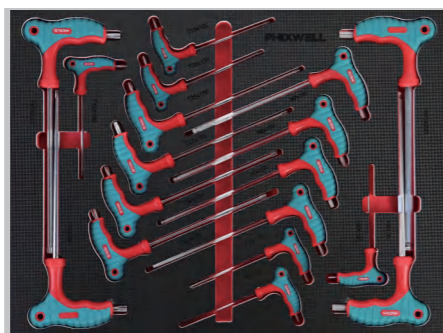

16PCS



51PCS

241 PCS TOOL CABINET

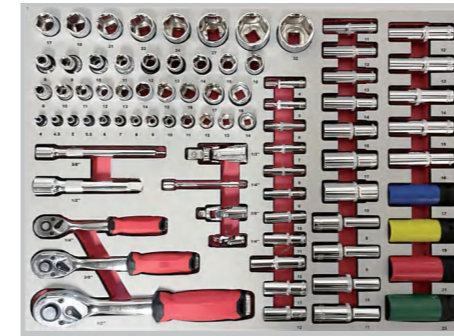

80PCS



45PCS



38PCS



18PCS



20PCS



ITEM NO.	719510
PACKAGE SIZE	790X490X850 MM
N.W./G.W.	83/87 KGS
EMPTY G.W.	55.5 KGS
1X40 HQ	207 SETS



25PCS

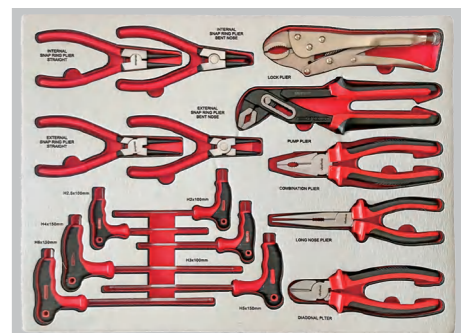

15PCS

264 PCS TOOL CABINET



ITEM NO.	719511
PACKAGE SIZE	790X500X860 MM
N.W./G.W.	55/59 KGS
EMPTY N.W./G.W.	43.8 KGS
1X40 HQ	207 SETS

251 PCS TOOL CABINET



ITEM NO.	719512
PACKAGE SIZE	905X485X840 MM
N.W./G.W.	84/88 KGS
EMPTY N.W./G.W.	58 KGS
1X40 HQ	183 SETS

292 PCS TOOL CABINET

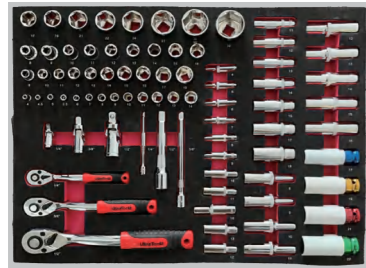

80PCS

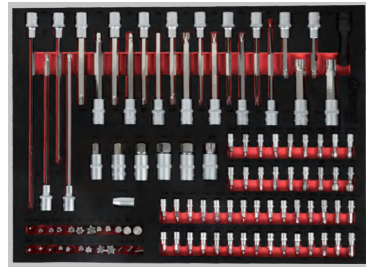

102PCS



16PCS



14PCS



16PCS



21PCS

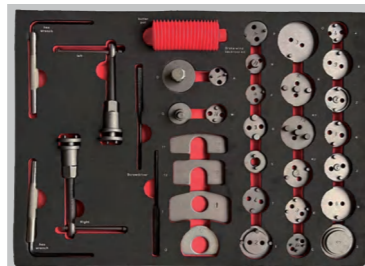

35PCS



8PCS

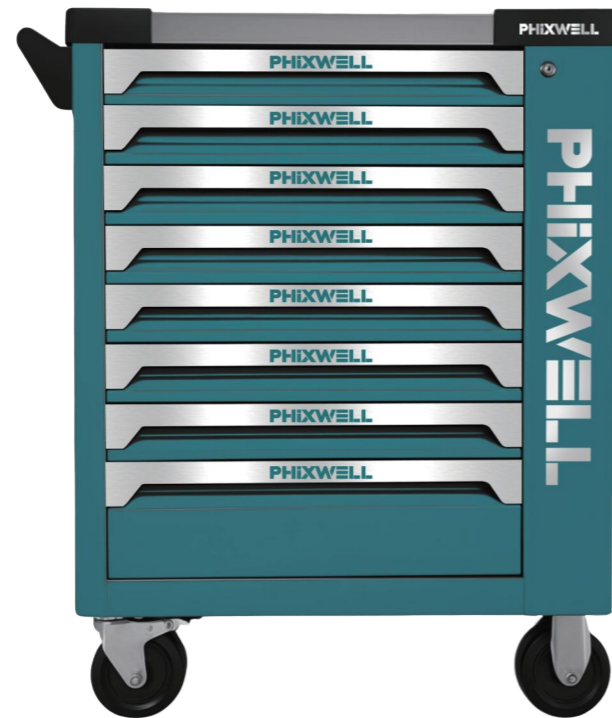

ITEM NO.	719513
PACKAGE SIZE	770X490X850 MM
N.W./G.W.	80/84 KGS
EMPTY G.W.	56 KGS
1X40 HQ	216 SETS

287 PCS TOOL CABINET



144PCS



85PCS

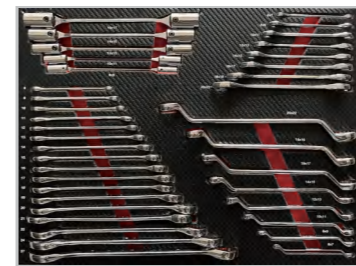

38PCS

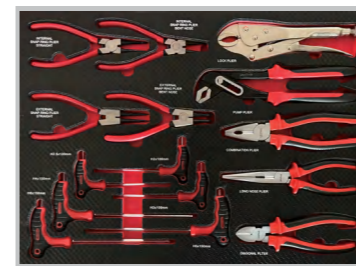

15PCS



20PCS



25PCS



ITEM NO.	719514
PACKAGE SIZE	1065X490X765 MM
N.W./G.W.	85/88 KGS
EMPTY G.W.	58 KGS
1X40 HQ	156 SETS

319 PCS TOOL CABINET

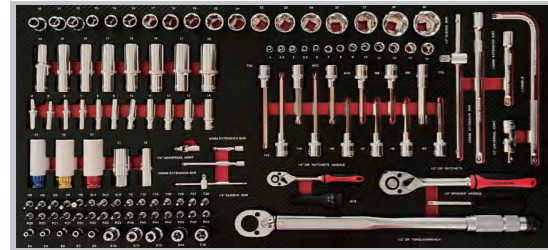

121PCS



39PCS

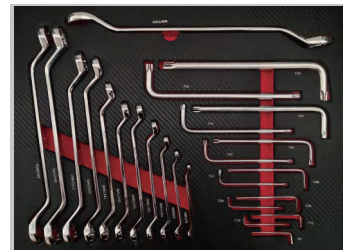

25PCS



12PCS



19PCS



23PCS

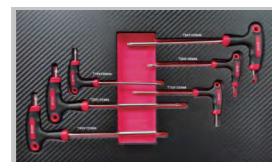

6PCS



10PCS

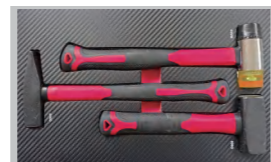

3PCS



61PCS



ITEM NO.	719515
PACKAGE SIZE	1010X500X800 MM
N.W./G.W.	109/113 KGS
EMPTY G.W.	80 KGS
1X40 HQ	148 SETS

254 PCS TOOL CABINET

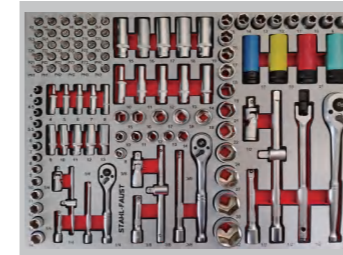

111PCS



45PCS

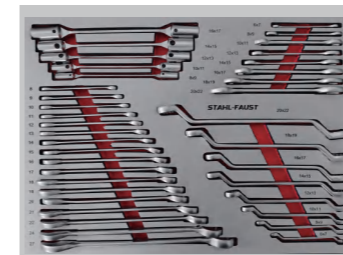

38PCS



15PCS



20PCS



25PCS

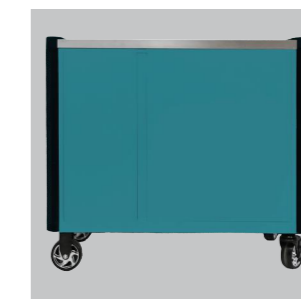

ITEM NO.	719516
PACKAGE SIZE	1140X550X810 MM
N.W./G.W.	88 /92 KGS
EMPTY G.W.	62 KGS
1X40 HQ	126 SETS

319 PCS TOOL CABINET



121PCS



39PCS



25PCS



12PCS



19PCS



23PCS



6PCS



10PCS

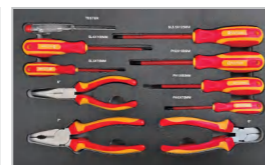

3PCS

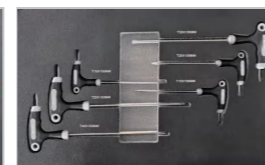

61PCS

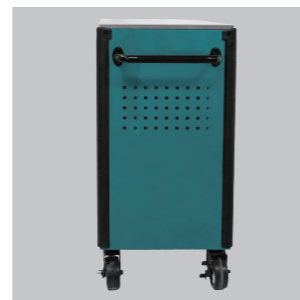

ITEM NO.	719517
PACKAGE SIZE	1070X530X890 MM
N.W./G.W.	112/117 KGS
EMPTY G.W.	82 KGS
1X40 HQ	136 SETS

358 PCS TOOL CABINET

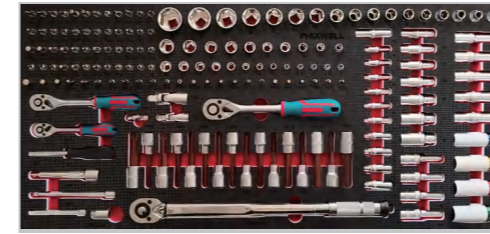

171PCS

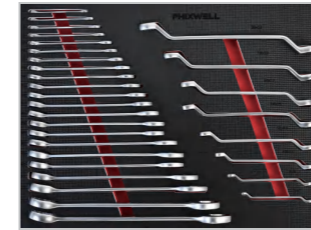

30PCS



16PCS



9PCS

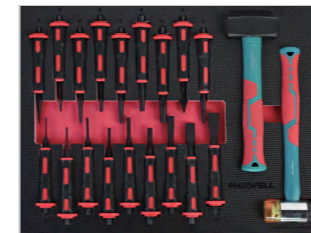

20PCS



18PCS

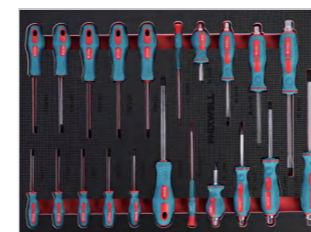

21PCS



ITEM NO.	719518
PACKAGE SIZE	1070X530X890 MM
N.W./G.W.	120/125 KGS
EMPTY G.W.	90 KGS
1X40 HQ	136 SETS



7PCS

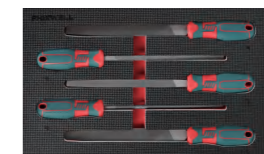

5PCS



61PCS

319 PCS TOOL CABINET

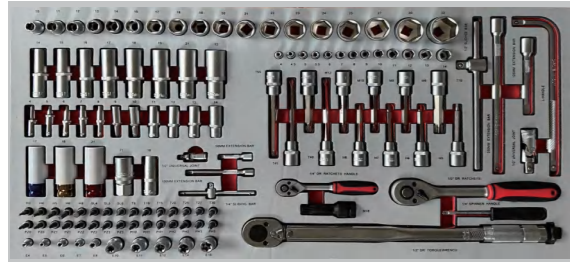

121PCS



39PCS



25PCS



12PCS

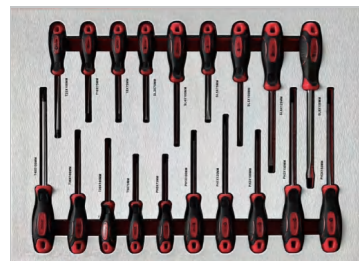

19PCS



23PCS

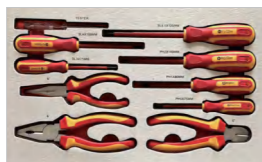

10PCS

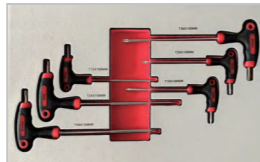

6PCS



3PCS



61PCS



ITEM NO.	719519
PACKAGE SIZE	1090X590X940 MM
N.W./G.W.	125/130 KGS
EMPTY G.W.	100 KGS
1X40 HQ	108 SETS

377 PCS TOOL CABINET

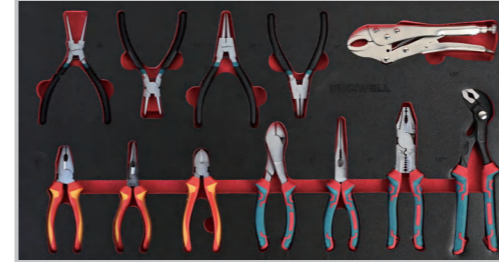

12PCS



22PCS



41PCS



36PCS



12PCS



12PCS



14PCS

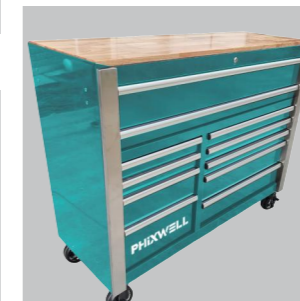

ITEM NO.	719520
PACKAGE SIZE	1330X550X980 MM
N.W./G.W.	176/181 KGS
EMPTY G.W.	120 KGS
40 HQ	66 SETS

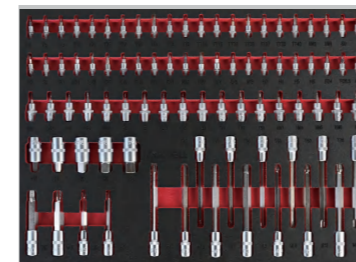

88PCS



6PCS



23PCS

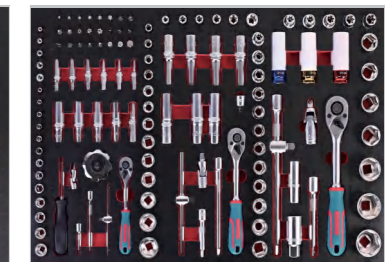

111PCS

419 PCS TOOL CABINET

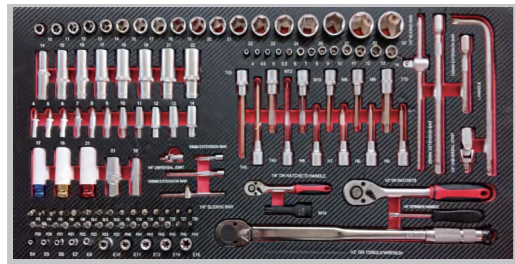

121PCS

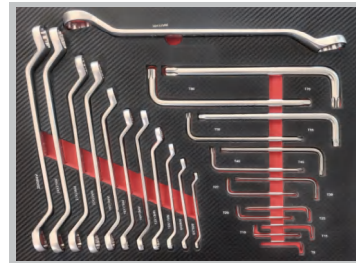

25PCS



39PCS



12PCS

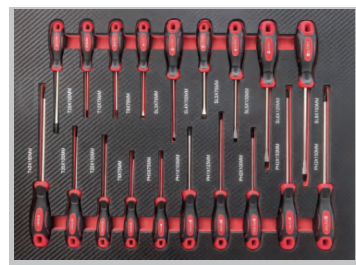

19PCS



23PCS



10PCS

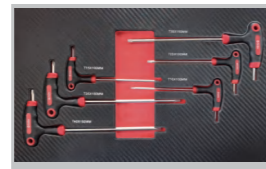

6PCS



3PCS



161PCS



ITEM NO.	719521
PACKAGE SIZE	1000X495X805MM/1050X385X450MM
N.W./G.W.	105/18.5 112/20.5 KGS
EMPTY G.W.	90/18.5 KGS
40 HQ	92 SETS

343 PCS TOOL CABINET

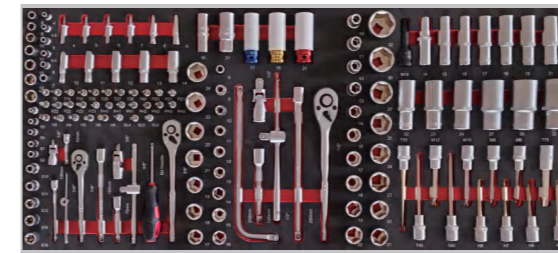

146PCS



3PCS



9PCS

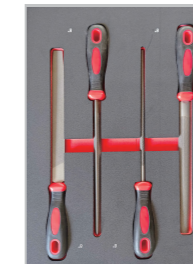

4PCS



35PCS

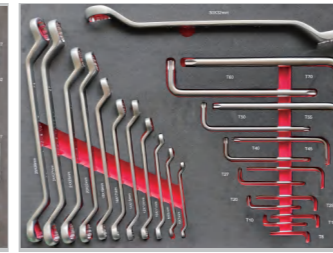

25PCS



30PCS



13PCS



21PCS

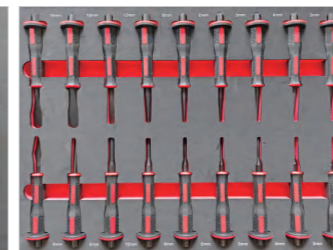

18PCS

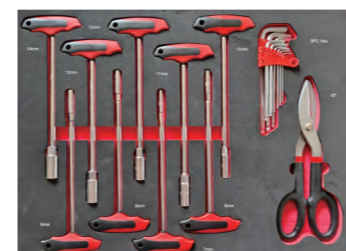

19PCS

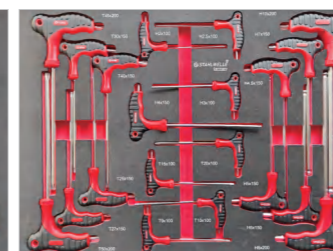

20PCS



ITEM NO.	719522
PACKAGE SIZE	1140X510X975MM/1080X370X440MM
N.W./G.W.	140/18.5 143/20.5 KGS
EMPTY G.W.	112/18.5 KGS
40 HQ	80 SETS

310 PCS TOOL CABINET

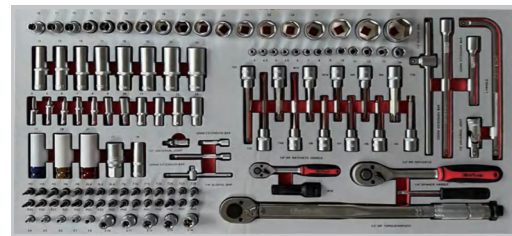

121PCS



39PCS

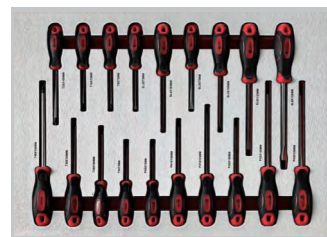

19PCS



12PCS



23PCS



7PCS



9PCS

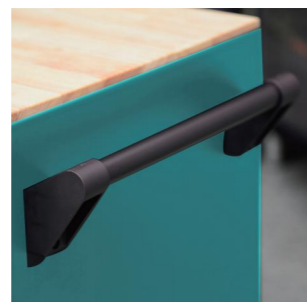

ITEM NO.	719523
PACKAGE SIZE	1000X495X805 MM
N.W./G.W.	110 /115 KGS
EMPTY G.W.	78 KGS
1X40 HQ	148 SETS



3PCS



61PCS

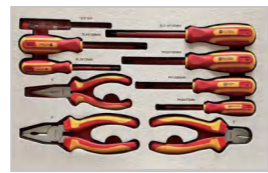

10PCS

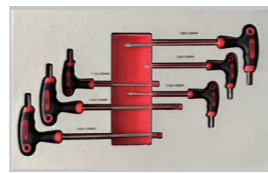

6PCS

323 PCS TOOL CABINET

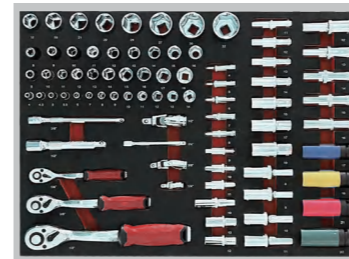

80PCS

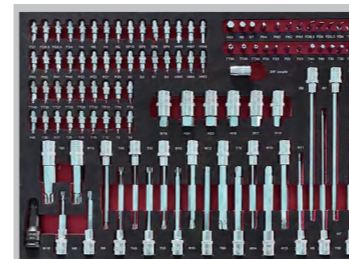

102PCS



56PCS



11PCS



38PCS



24PCS



ITEM NO.	719524
PACKAGE SIZE	1050X500X830 MM
N.W./G.W.	105 /110 KGS
EMPTY G.W.	75 KGS
1X40 HQ	144 SETS



12PCS

309 PCS TOOL CABINET



80PCS

9PCS



102PCS

21PCS

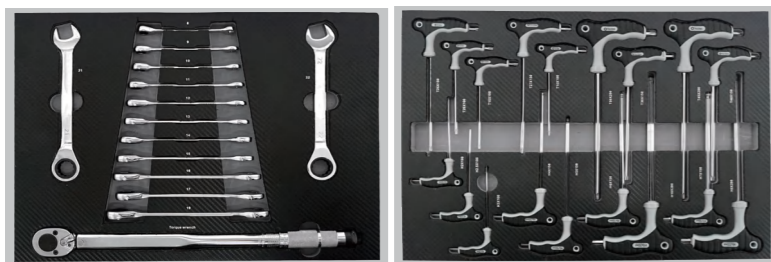

14PCS

18PCS



16PCS

9PCS



33PCS

7PCS



ITEM NO.	719525
PACKAGE SIZE	785X485X1080 MM
N.W./G.W.	100 /105 KGS
EMPTY G.W.	60 KGS
1X40 HQ	138 SETS



ITEM NO.	719701
PACKAGE SIZE	620X330X760 MM
N.W./G.W.	21/22 KGS
1X40 HQ	366 SETS



ITEM NO.	719702
PACKAGE SIZE	675X382X700 MM
EMPTY N.W./G.W.	17/19 KGS
1X40 HQ	325 SETS



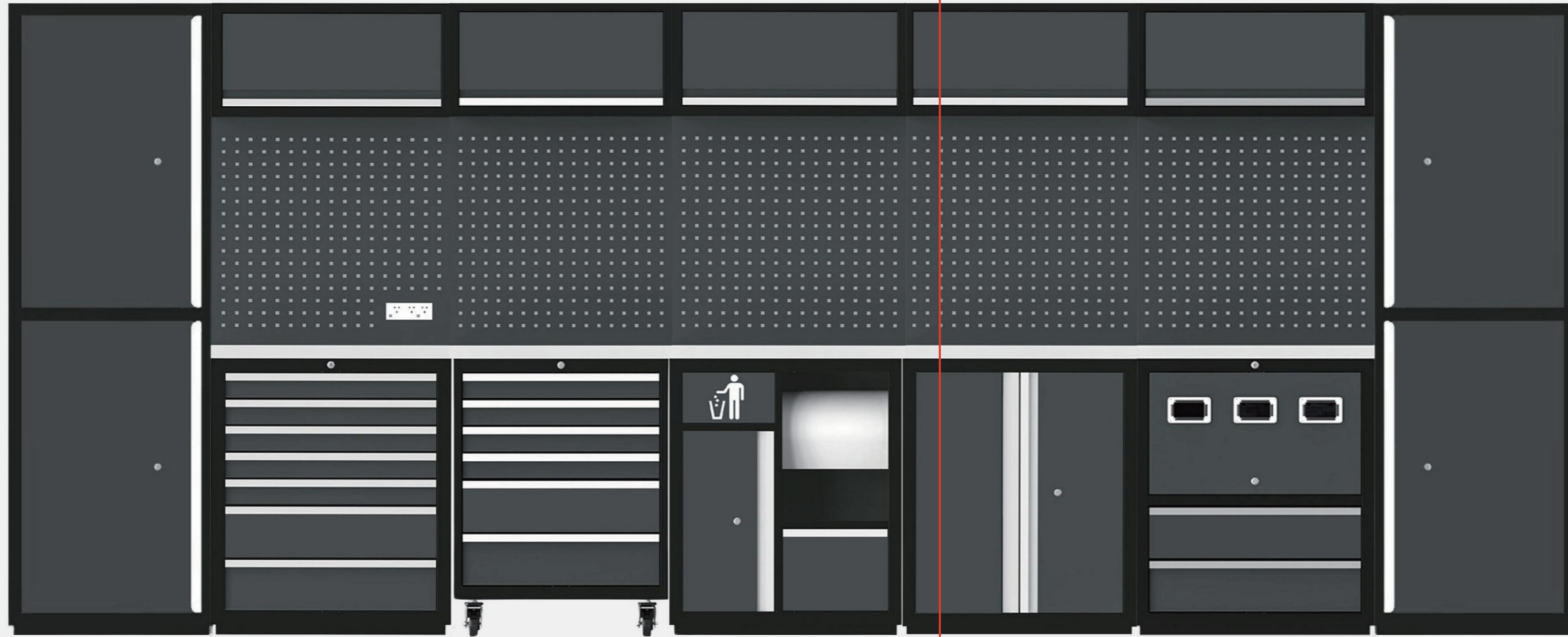

ITEM NO.: 719610
 SIZE: 4600x500x2000 mm

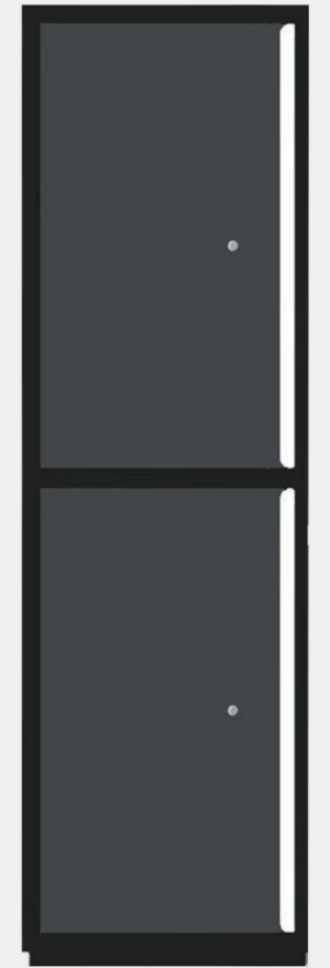

High cabinet with 2doors
 600x500x2000(mm)



Cabinet with power
 680x500x1020(mm)



Garbage bin
 680x500x1020(mm)



Mobile Cabinet
 680x500x1020(mm)



7draws cabinets
 680x500x1020(mm)

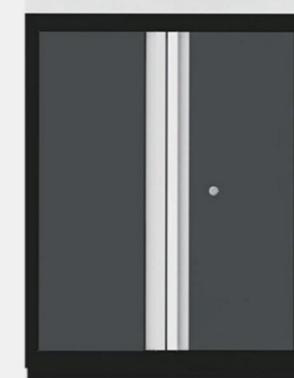

Double-door cabinet
 680x500x1020(mm)

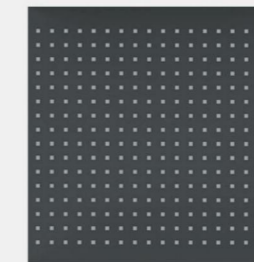

Signboard
 680x700x40(mm)



Wall cabinet
 680x280x350(mm)



ITEM NO.: 719608

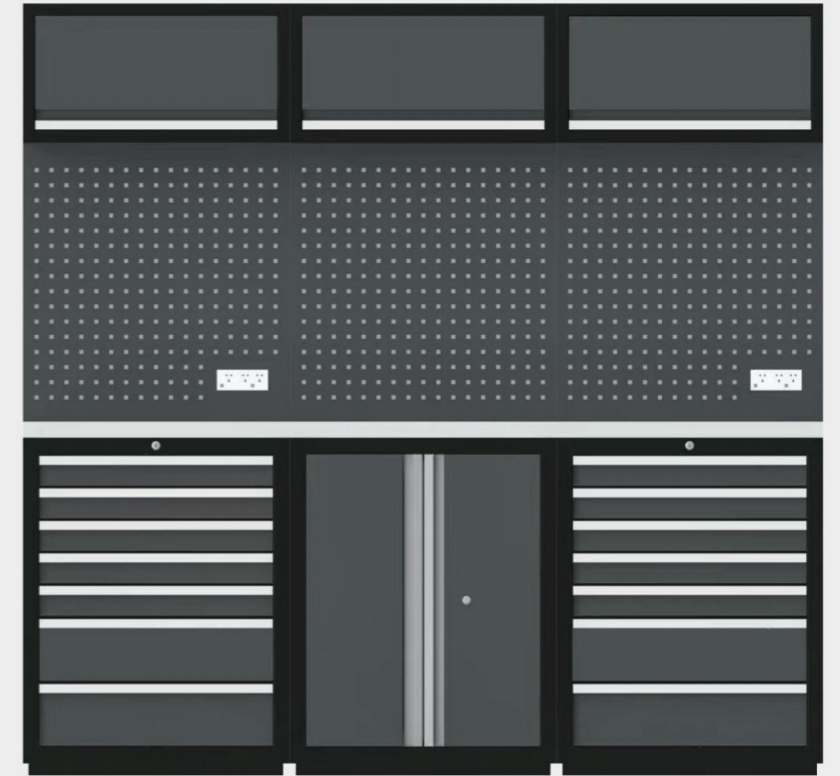

ITEM NO.: 719603

719603 2040x500x2000(mm)	719604 2720x500x2000(mm)	719605 2640x500x2000(mm)	719606 3320x500x2000(mm)	719607 3240x500x2000(mm)	719608 3920x500x2000(mm)
-----------------------------	-----------------------------	-----------------------------	-----------------------------	-----------------------------	-----------------------------



ITEM NO.: 719604

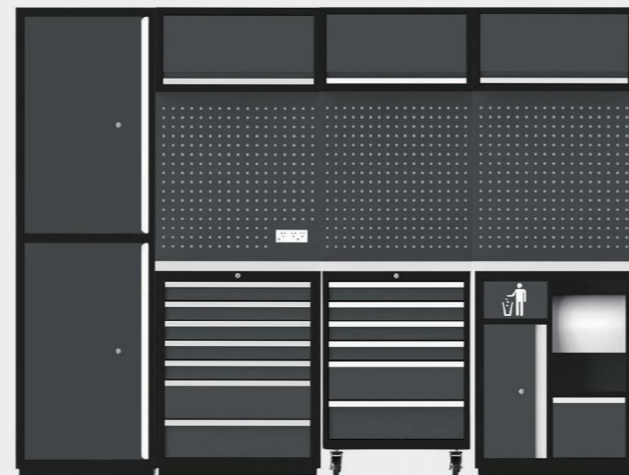

ITEM NO.: 719605



ITEM NO.: 719606

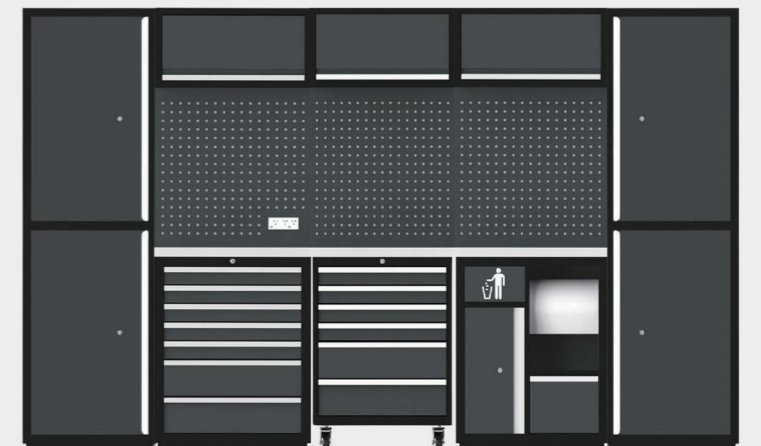

ITEM NO.: 719607



ITEM NO.: 719601
SIZE: 2592x458x1830 mm

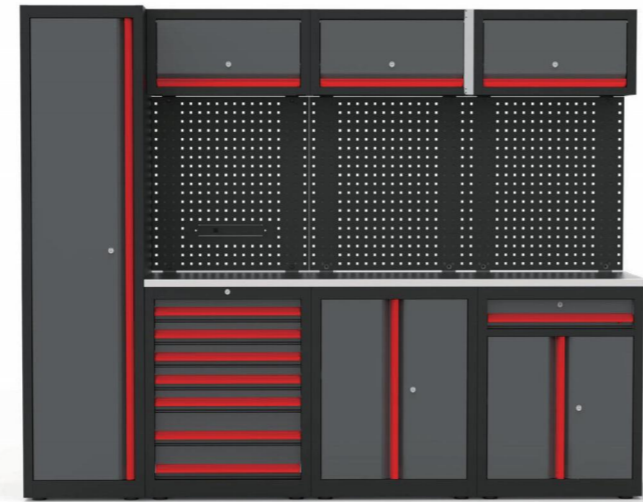

ITEM NO.: 719602
SIZE: 2555x600x2000 mm



ITEM NO.: 719609
SIZE: 4425x600x2000 mm



ITEM NO
719703
CART SIZE
730x380x800
BOARD THICKNESS
1.0mm
COLUMN THICKNESS
1.2mm



ITEM NO
719706
CART SIZE
750x500x800
900x500x800
1000x600x800
BOARD THICKNESS
1.5mm
COLUMN THICKNESS
2.5mm



ITEM NO
719704
CART SIZE
730x380x800+450
BOARD THICKNESS
1.0mm
COLUMN THICKNESS
1.2mm



ITEM NO
719707
CART SIZE
750x500x800+450
900x500x800+450
1000x600x800+450
BOARD THICKNESS
1.5mm
COLUMN THICKNESS
2.5mm



ITEM NO
719705
CART SIZE
730x380x800+450
BOARD THICKNESS
1.0mm
COLUMN THICKNESS
1.2mm



ITEM NO
719710
CART SIZE
770*610*807mm



ITEM NO
719709
CART SIZE
820*355*760mm



ITEM NO
719708
CART SIZE
700*350*770

717006



215PCS ALUMINUM TROLLEY TOOL SET

- 10pcs ratchet handle 8-9-10-11-12 -13-14-15-17-19
- 1pc 8' diagonal cutting plier
- 1pc 8' adjustable wrench
- 1pc 10' water pumping plier
- 1pc 8' combination plier
- 1pc 8' long nose plier
- 16pcs 1/2 sockets 10-11-12-13-14 -15-17-19-20-21 -22-23-24-27-30-32
- 13pcs 1/4 sockets 4-4.5-5-5.5-6 -7-8-9-10-11-12 -13-14
- 5pcs 1/2 E sockets 10-11-12-14-16
- 5pcs 1/4 E sockets 4-5-6-7-8
- 16pcs bits
- 8pcs 1/4 deep sockets 6-7-8-9-10 -11-12-13
- 6pcs 1/2 deep sockets 12-13-14-15 -17-19
- 1pc 1/4 square handle
- 1pc 1/4 sliding T bar
- 1pc 1/2 sliding T bar
- 1pc 1/2 5' extension bar
- 1pc 1/4 4' extension bar
- 1pc 1/4 2' extension bar
- 2pcs universal joint 1/4&1/2
- 2pcs spark plug 16&21mm
- 2pcs ratchet handle 1/2&1/4
- 10pcs screwdrivers SL6X38-SL5X100 -SL6X100MM-SL6X150MM-SL8X150MM -PH2X38MM-PH1X100MM-PH2X100MM -PH2X150MM-PH3X150MM
- 6pcs Insulated screwdriver PHOX75MM -SL3X75MM-PH1X80MM-SL4X100MM -PH2X100MM-SL5.5X125MM
- 7pcs precision screwdrivers SL2X50MM -SL2.5X50MM-SL3X50MM-PHOX50MM -PH00X50MM-PH000X50MM-T5X50MM
- 1PC 80Z claw hammer
- 1pc 40mm install hammer
- 1pc 8' crimping plier
- 1pc scissor 8'
- 9pcs hex key
- 1pc 5mm tape
- 80pcs haredware case
- 1pc 18mm knife
- 1pc 9' level
- 1pc 5m measure tape
- MEAS: 25X43X53 CM
- QTY: 1 SETS/CTN
- G.W: 17 KGS

717001



213 PCS ALUMINUM TROLLEY TOOL SET

- 9pcs spanners
- 1pc diagonal cutting plier
- 1pc adjustable wrench
- 1pc long nose plier
- 1pc carp plier
- 1pc water pump plier
- 15pcs Hex Socket Inserts 1/4 4, 4.5, 5, 5.5, 6, 6.5, 7, 7.5, 8, 9, 10, 11, 12, 13, 14mm
- 14pcs Hex Socket Inserts 1/2 8, 9, 10, 11, 12, 13, 14, 15, 16, 17, 18, 19, 20, 30mm
- 2pcs 1/4 Extension Bar
- 1pcs 1/2 Extension Bar
- 2pcs 1/4&1/2 Universal Joint
- 1pc Flexible Extension Bar
- 2pcs 1/4&1/2 Sliding T-bar
- 2pcs 1/2 Spark Plug Socket, 16mm and 21mm
- 1pc 1/4 Spinner Handle
- 2pcs Ratchet handle 1/2&1/4
- 11pcs screwdrivers
- 3pcs insulation screwdrivers
- 1pc tester
- 48pcs bits
- 16pcs hex key
- 6pcs precision screwdrivers
- 1pc bit handle
- 1pc Tire pressure pen
- 1pc extension bar
- 1PCS Criming plier
- 1pc glue gun(with sticker)
- 1pc scissor
- 1pc knife
- 1pc hammer
- 1pc level
- 2pcs clamps
- 60pcs hardware box
- 1pc 5m measure tap
- QTY:1 SETS/CTN
- G.W: :12 KGS
- MEAS: 38x22x51.5 CM

717011



98PCS ALUMINUM TOOL SET

- 8pcs spanners 7-9-11-13-15 -17-19-23
- 6pcs screwdrivers PH2X100MM/ PH1X100MM/PH0X75MM -6X100MM-5X100MM--3X75MM
- 2PCS precision screwdrivers +2.5mm-2.5mm
- 1pc 8' crimping plier
- 1pc 7' diagonal plier
- 1pc 6' combination plier
- 1pc 10' water pumping plier
- 1pc 8' file
- 1pc level
- 9pcs hex ley
- 1pc 3m measure tape
- 1pc knife
- 10pc blade
- 12pcs 1/4 sockets4-4.5-5-5.5 -6-7-8-9-10-11-12-13
- 4pcs 3/8 sockets 14-15-17-19
- 1pc adaptor 3/8&1/4
- 1pc 21mm spark plug 3/8
- 2pc 3/8 extention bar 3'6'
- 1pc vernier caliper
- 1pc 3/8 ratchet handle
- 1pc1/4 bit handle
- 1pc hammer 300g
- 30pcs bits
- 1pc 3/8 universal joint
- MEAS: 45X31X36 CM
- QTY: 2 SETS/CTN
- G.W: 17 KGS

717002



186PCS ALUMINUM TROLLEY TOOL SET

- 15pcs Hex Socket Inserts 1/4 4, 4.5, 5, 5.5, 6, 6.5, 7, 7.5, 8, 9, 10, 11, 12, 13, 14mm
- 14pcs Hex Socket Inserts 1/2 8, 9, 10, 11, 12, 13, 14, 15, 16, 17, 18, 19, 20, 30mm
- 2pcs 1/4 Extension Bar
- 1pcs 1/2 Extension Bar
- 2pcs 1/4&1/2 Universal Joint
- 1pc Flexible Extension Bar
- 2pcs 1/4&1/2 Sliding T-bar
- 2pcs 1/2 Spark Plug Socket, 16mm and 21mm
- 1pc 1/4 Spinner Handle
- 2pcs Ratchet handle 1/2
- 9pcs spanners
- 1pc diagonal cutting plier
- 1pc adjustable wrench
- 1pc long nose plier
- 1pc carp plier
- 1pc water pump plier
- 9pcs screwdrivers
- 2pcs insulation screwdrivers
- 1pc tester
- 24pcs bits
- 9pcs hex key
- 6pcs precision screwdrivers
- 1pc bit handle
- 1pc Tire pressure pen
- 1pc extension bar
- 1PCS Criming plier
- 1pc glue gun(with sticker)
- 1pc scissor
- 1pc knife
- 1pc hammer
- 1pc level
- 2pcs clamps
- 60pcs hardware box
- 1pc 5m measure tape
- QTY:1 SETS/CTN
- G.W: :13.5 KGS
- MEAS: 38x22x51.5 CM

717012



157PCS ALUMINUM TROLLEY TOOL SET

- 1 pc 10" water pump wrench
- 1 pc 7" combination plier
- 1 pc 6" side cutting plier
- 1 pc 6" long nose plier
- 1 pc file
- 1 pc stripping plier
- 5 pcs chisel
- 1pc torpedo level,9"
- 6pcs screwdriver
- 2pcs precision screwdriver
- 1pc voltage tester
- 1pc cable knife
- 10pcs carbon steel blade
- 1pc stainless steel electric scissor,7"
- 1pc handsaw
- 6pcs saw blade
- 1pc adjustable wrench,8"
- 9pcs combination spanner:8-10-11-12 -13-15-17-19-22mm
- 9pcs hex key wrench:1.5-2-2.5-3-4-5 -6-8-10mm,
- 1pc 1/4" ratchet handle
- 10pcs 1/4"X25MM sockets,4-5-6-7-8 -9-10-11-12-13mm
- 2pcs 1/4" extension bar
- 1pc 1/4" sliding bar
- 1pc flexible extension
- 1pc 1/4" universal joint
- 1pc 1/4" square handle for socket
- 1pc 1/4" adaptor
- 40pcs 1/4"X25mm bits
- 15pcs 5/16"X30mm bits
- 1pc 1/2" ratchet handle
- 14pcs 1/2" sockets 14-15-16-17-18-19-20-21-22-23-24-27 -30-32mm,
- 2pcs 1/2" extension bar
- 1pc 1/2" 3-way adaptor, 3/8"(F)X1/2"(M)
- 2pcs 1/2" spark plug,16mm-21mm,
- 1pc 1/2" universal joint,
- 1pc socket adaptor
- 1pc measuring tape,3M
- 1pc machinist's hammer with fiberglass handle,300g
- 1pc vernier caliper
- MEAS: 51.5X20X37.5 CM
- QTY: 1 SETS/CTN
- G.W: 14 KGS

717003



182 PCS ALUMINUM TROLLEY TOOL SET

- 9pcs ratchet spanners
- 1pc diagonal cutting plier
- 1pc adjustable wrench
- 1pc long nose plier
- 1pc carp plier
- 1pc water pump plier
- 15pcs Hex Socket Inserts 1/4 4, 4.5, 5, 5.5, 6, 6.5, 7, 7.5, 8, 9, 10, 11, 12, 13, 14mm
- 14pcs Hex Socket Inserts 1/2 8, 9, 10, 11, 12, 13, 14, 15, 16, 17, 18, 19, 20, 30mm
- 2pcs 1/4 Extension Bar
- 1pcs 1/2 Extension Bar
- 2pcs 1/4&1/2 Universal Joint
- 1pc Flexible Extension Bar
- 2pcs 1/4&1/2 Sliding T-bar
- 2pcs 1/2 Spark Plug Socket, 16mm and 21mm
- 1pc 1/4 Spinner Handle
- 2pcs Ratchet handle 1/2&1/4
- 11pcs screwdrivers
- 3pcs insulation screwdrivers
- 1pc tester
- 24pcs bits
- 9pcs hex key
- 6pcs precision screwdrivers
- 1pc bit handle
- 1pc Tire pressure pen
- 1pc extension bar
- 1pc criming plier
- 1pc glue gun(with sticker)
- 1pc locking plier
- 1pc knife
- 1pc hammer
- 1pc level
- 2pcs clamps
- 60pcs hardware box
- 1pc 5m measure tape
- QTY:1 SETS/CTN
- G.W: :12 KGS
- MEAS: 38x22x51.5 CM

717004



180 PCS ALUMINUM TROLLEY TOOL SET

- 10pcs combination wrenches
 - 1pc bit driver handle
 - 1pc 3/8 to 1/4 adaptor
 - 1pc 3/8 extension bar
 - 2pcs universal joint 1/4&3/8
 - 2pcs spark plug sockets
 - 12pcs hex key
 - 1pc 3/8 ratchet handle
 - 1pc tire gauge
 - 1pc soft extension bar
 - 22pcs 1/4 sockets
 - 8pcs 3/8 sockets
 - 1pc long nose plier 6'
 - 1pc diagonal cutting plier 6'
 - 1pc linesman plier6'
 - 1pc slip joint plier6'
 - 1pc water pump plier9.5'
 - 7pcs screwdrivers
 - 20pcs bits
 - 1pc adjustable wrench 8'
 - 1pc locking plier7'
 - 4pcs precision screwdrivers
 - 1pc measure tape 5m
 - 1pc crimping plier
 - 1pc saw (with blade)
 - 1pc knife
 - 10pcs blades
 - 1pc scissor
 - 1pc tape
 - 60pcs hardware box
 - 1pc 300g hammer
 - 1pc level
 - 2pcs plastic clips
- QTY:1 SETS/CTN
G.W. :11 KGS
MEAS: 38x20x51CM

717009



52 PCS ALUMINUM TOOL SET

- 8pcs double wrench, 6x7,8x9,10x11, 12x13,14x15,16x17,18x19,21x23
 - 6pcs screwdrivers, PH0*75mm, PH1*100mm, PH2*100mm, SL3*75mm, SL5*100mm, SL6*100mm
 - 2pcs precision screwdrivers, PH00x50mm, SL2.5x50mm
 - 1pc 1/4 bit driver handle
 - 1pc tester
 - 1pc 10*d4' water pumping plier
 - 2pcs 6'pliers(diagonal cutting plier/ combination plier)
 - 1pc 3/8 ratchet handle
 - 8pcs 1/4 bit sockets PH1-PH2-PZ1 -PZ2-H3-H4-H5-H6
 - 8pcs 1/4 sockets 4-4.5-5-5.5-6-7 -8-9mm
 - 1pc adapter 3/8&1/4
 - 1pc holder
 - 9pcs 3/8 sockets:9-10-11-12-13-14-15-17-19mm
 - 1pc 3/8*21mm spark plug
 - 1pc 3/8*3 extension bar
 - 1pc 3/8*6 extension bar
- QTY:2SETS/CTN
GW:12.6KGS
MEAS:45X31X36CM

717005



108 PCS ALUMINUM TROLLEY TOOL SET

- 1pc 6" long nose plier
 - 1pc 6"diagonal cutting plier
 - 1pc 6 linesman plier
 - 1pc 6"slip joint plier
 - 1pc9.5" water pump plier
 - 7pcs screwdrivers
 - 20pcs bits
 - 1pc 8"adjustable wrench
 - 1pc 7" locking plier
 - 4pcs precision screwdrivers
 - 1pc measure tape 5m
 - 1pc 8" crimping plier
 - 1pc bit driver handle
 - 1pc scissors
 - 1pc knife
 - 1pc 8 oz hammer
 - 1pc level
 - 2pcs plastic clips
 - 1pc insulation tape
 - 60pcs assortment fasteners in a plastic box
- QTY: 1SET/CTN
G.W:8 KGS
MEAS:51x38x20 CM

717010



100 PCS ALUMINUM TOOL SET

- 9pcs spanners:8-10-11-12-13-14-17-19-22MM
 - 13pcs 1/2 dr sockets:14-15-16-17-18-19-20-21-22-24-27-30-32MM
 - 13pcs 1/4 dr sockets:4-4.5-5-5.5-6-7-8-9-10-11-12-13-14
 - 9pcs precision screwdrivers
 - 46pcs bits
 - 1pc bit handle
 - 2pcs 1/2 extension bar
 - 1pc 1/4 extension bar
 - 1pc 1/4 sliding t-bar
 - 2pcs ratchet handle 1/4&1/2
 - 3pcs adaptor
- QTY: 2 SETS/CTN
GW: 10 KGS
MEAS: 40X30X22 CM

717008



93 PCS ALUMINUM TOOL SET

- 11pcs 3/8 sockets
 - 1pc 300g hammer
 - 1pc 3/8 ratchet handle
 - 1pc adjustable wrench
 - 2pcs extension bar
 - 1pc bit driver handle
 - 1pc holder
 - 1pc adaptor
 - 1pc measure tape 3m
 - 30pcs bits box(with extension bar)
 - 1pc combination plier
 - 1pc diagonal cutting plier
 - 1pc long nose plier
 - 1pc knife
 - 16pcs drill box
 - 4pcs screwdrivers
 - 2pcs keys
 - 1pc hack saw
 - 9pcs hex key
 - 7pcs spanners
- QTY:2 SETS/CTN
G.W. :14KGS
MEAS: 46x36x30.5CM

717007



125 PCS ALUMINUM TROLLEY TOOL SET

- 1pc circlip plier(extra with 3 replace tools)
 - 1pc knife
 - 10pcs blades
 - 1pc multifunction scissor
 - 1pc long nose plier6'
 - 1pc diagonal plier6'
 - 1pc combination plier6'
 - 1pc clamp plier
 - 1pc water pump plier 9.5
 - 1pc adjustable wrench 8'
 - 1pc fitter hammer
 - 1pc crimping plier
 - 1pc measure tape 5m
 - 1pc hack saw(with 3 blades)
 - 1pc chisel handle
 - 5pcs screwdrivers
 - 5pcs chisel
 - 1pc tester pen
 - 9pcs hex key
 - 1pc precision screwdriver handle
 - 3pcs precision screwdrivers
 - 5pcs chisel
 - 1pc level
 - 2pcs ratchet handle1/4&1/2
 - 11pcs 1/2 sockets
 - 13pcs 1/4 sockets
 - 2pcs extension bar1/4
 - 1pc extension bar1/2
 - 2pcs spark plug16&21mm
 - 30pcs bits box(with extension bar)
 - 8pcs spanners
 - 2pcs keys
- QTY:1 SETS/CTN
G.W. :11KGS
MEAS: 50x22x41CM

717106



201PCS TOOL SET

- 16pcs hex key wrench
- 20pcs bits
- 2pcs screwdriver
- 1pc 6" long nose pliers
- 1pc tester
- 1pc bit holder
- 1pc claw hammer
- 1pc hand saw
- 1pc knife
- 150pcs small nails in a plastic box
- 1pc insulating tape 3M
- 6pcs precision screwdriver

MEAS: 50X24X31 CM
 QTY: 8 SETS/CTN
 G.W: 14 KGS

717103



90PCS TOOL SET

- 16pcs hex key wrench
- 1pc level
- 20pcs bits
- 1pc 6" diagonal cutting pliers
- 1pc 6" long nose pliers
- 1pc 6" adjustable wrench
- 1pc claw hammer 8OZ
- 40pcs small nails in a plastic box
- 1pc ratchet bit holder
- 1pc measure tape 3M
- 4pcs precision screwdriver
- 1pc knife
- 1pc wire stripper
- 1pc blow case

MEAS: 50X24X31 CM
 QTY: 8 SETS/CTN
 G.W: 14 KGS

717102



92PCS TOOL SET

- 40pcs small nails in a plastic box
- 20pcs bits with holder
- 2pcs clips
- 1pc 6" combination pliers
- 9pcs 1/4" socket with holder
- 1pc bit holder
- 1pc claw hammer 8OZ
- 1pc 6" combination wrench
- 1pc level
- 8pcs hex key wrench
- 1pc measure tape 3M
- 6pcs precision screwdriver
- 1pc blow case

MEAS: 50X24X31 CM
 QTY: 8 SETS/CTN
 G.W: 14 KGS

717110



105PCS TOOL SET

- 11pcs spanners 8-9-10-11-12-13-14-15-17-18-19
- 2pcs ratchet handle 1/2&1/4
- 11pcs 1/4 sockets 4-5-6-7-8-9-10-11-12-13-14
- 15pcs 10-11-12-13-14-15-17-18-19-20-21-22-23-24-27
- 40pcs bits
- 8pcs hex key
- 4pcs screwdrivers PH2X100MM -PH1X75MM-5X75MM-6X100MM
- 1pc screwdriver handle
- 2pcs 1/4 2'4'extension bar
- 2pcs universal joint 1/2&1/4
- 1pc soft extension bar
- 2pcs spark plug 16&21mm
- 1pc 1/2 sliding T bar 10'
- 1pc 1/2 5' extension bar
- 1pc diagonal plier
- 1pc long nose plier
- 1pc 10'water pumping plier

MEAS: 44X19X50 CM
 QTY: 2 SETS/CTN
 G.W: 16 KGS

717112



128PCS TOOL SET

- 11pcs Combination Wrenches: 8-9-10-11-12-13-14-15-17-18-19mm
- 2pcs Ratchet Wrenches 24 Teeth: 1/4" & 1/2"
- 11pcs Sockets 1/4 DR 4-5-6-7-8-9-10-11-12-13-14mm
- 15pcs Sockets 1/2 DR 10-11-12-13-14-15-17-18-19-20-21-22-23-24-27mm
- 2pcs extension bars 1/2" - 5" and 10"
- 1pc Sliding bar 1/4" - 145mm
- 2pcs Spark plug socket 1/2"-16MM and 21MM
- 2pcs Universal joints: 1/4" and 1/2"
- 2pcs Extension bar 1/4"-2" and 4"
- 16pcs Hex wrenches: 1.5/2/2.5/3/4/5/5.5/6 mm; T9-T10-T15-T20-T25-T27-T30-T40
- 1pc Combination pliers of 6"
- 1pc Measure tape 5M
- 10pcs Drill Bits (masonry drill 3-4-5-6-8mm; wood drill 2-3-4-5-6mm)
- 40pcs Bits (-)3-3-4-4-5-6-8,S1-S2-S3 H2-H3-H4-H5-H6-H7, (Y)1-2-3-4 T10-T15-T20-T25-T27-T30-T40 -PZ1-PZ2-PZ3 PHO-PHO-PH1-PH2-PH2-PH2 -PH3-PH3-AD
- 4pcs Screwdriver:(+) PH1X75MM, PH2X100MM,(-)5X75MM, 6X100MM
- 1pc Ratchet bit handle

MEAS: 43X27X49 CM
 QTY: 3 SETS/CTN
 G.W: 22 KGS

717113



115 PCS TOOL SET

- 16pcs hex key wrench
- 1pc 6" diagonal cutting pliers
- 1pc 6" long nose pliers
- 1pc 8" adjustable wrench
- 2pc double-end bit
- 1pc bit holder
- 1pc extension bar
- 1pc adapter
- 10pcs combination wrench
- 16pcs 1/4" socket
- 14pcs 3/8" socket
- 40pcs bits
- 1pc ratchet bit holder
- 5pcs precision screwdriver
- 4pcs screwdriver
- 1pc blow case

MEAS: 55x30x34 CM
 QTY: 4 SETS
 G.W: 20 KGS

717101



89 PCS TOOL SET

- 16pcs hex key wrench
- 20pcs bits
- 6pcs precision screwdriver
- 1pc level
- 1pc 6" adjustable wrench
- 1pc measure tape 3M
- 1pc claw hammer 8OZ
- 1pc bit holder
- 1pc 6" long nose pliers
- 1pc 6" diagonal cutting pliers
- 40pcs small nails in a plastic box
- 1pc blow case

MEAS: 41.5 X 34 X 27 CM
 QTY: 6 SETS
 G.W: 13 KGS

717107



160 PCS TOOL SET

- 6pcs combination wrench
- 1pc bit holder
- 10pcs bits with holder
- 1pc measure tape 3M
- 1pc 6" adjustable wrench
- 1pc knife
- 1pc 6" combination pliers
- 1pc hammer
- 1pc 6" long nose pliers
- 1pc 3/8" extension bar
- 1pc spark plug socket
- 1pc 3/8" to 1/4" adapter
- 1pc 3/8" ratchet handle
- 10pcs 1/4" socket
- 8pcs 3/8" socket
- 4pcs precision screwdriver
- 1pc level
- 16pcs hex key wrench
- 93pcs assortment fasteners in a plastic box
- 1pc blow case

MEAS: 38.5x36.5x34 CM
 QTY: 4 SETS
 G.W: 19.2 KGS

717108



190 PCS TOOL SET

- 4pcs clamp
- 1pc 6" long nose pliers
- 1pc 6" diagonal cutting pliers
- 1pc 6" adjustable wrench
- 70pc small nails in a plastic box
- 1pc 3/8" ratchet handle
- 4pcs precision screwdrivers
- 1pc 3/8" extension bar
- 1pc spark plug
- 1pc adapter
- 14pcs 1/4" socket
- 4pcs 3/8" socket
- 16pcs hex key wrench
- 50pcs bits 25mm
- 1pc 5" level
- 1pc 60mm bit extension bar
- 1pc ratchet bit holder
- 1pc 5.5" scissors
- 1pc bottle opener
- 4pcs spanner 6-7,8-9,10-11,12-13
- 1pc knife
- 10pcs knife blades
- 1pc blow case

MEAS: 38*26*52.5 CM
 QTY: 6 SETS
 G.W: 19 KGS

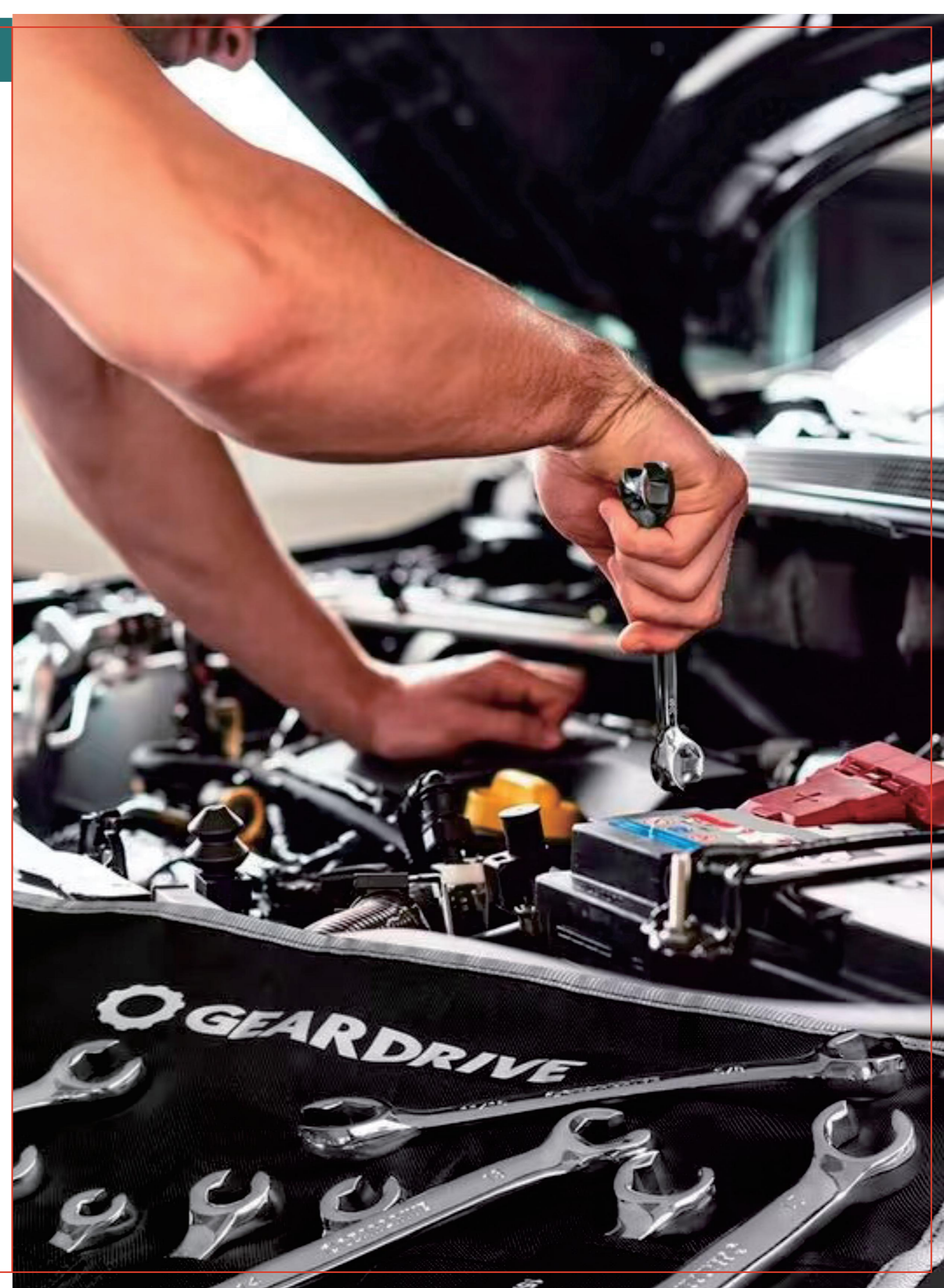



715002



108 PCS TOOL SET

13Pcs 1/4"Dr.Sockets:4,4.5,5,5.5, 6,7,8,9,10,11,12,13,14mm 13
 8Pcs 1/4"Dr. Deep Socket:6,7,8, 9,10,11,12,13mm 8
 5Pcs 1/4"E Type Dr.Sockets:E4, E5,E6,E7,E8 5
 1Pcs 1/4"Dr.Universal Joint 1
 1Pcs 1/4"Dr.Extension Bar:2" 1
 1Pcs 1/4"Dr.Extension Bar:4" 1
 1Pcs 1/4"Dr.Sliding T Handle: 110mm 1
 1Pcs 1/4"Dr.Spinner Handle: 150mm 1
 18Pcs 1/4"Inserted Reg Bit Sockets:Torx-T8,T10, T15,T20,T25,T27,T30;Hex-H3, H4,H5,H6;Phillips-PH1,PH2; Pozi-PZ1,PZ2;Slotted-FD4.0, FD5.5,FD6.5 18
 1Pcs 1/4"Dr.Ratchet Handle 1
 17Pcs 1/2"Dr.Hex Socket:10,11, 12,13,14,15,16, 17,18,19,20,21,22,24,27,30,32mm 17
 5Pcs 1/2"Deeo Dr.Sockets:14,15, 17,19,22mm 5
 8Pcs 1/2"E Type Dr.Socket:E10,E11, E12,E14,E16, E18,E20,E24 8
 1Pcs 1/2"Dr.Universal Joint 1
 2Pcs 1/2" Spark Plug Socket:16mm, 21mm 2
 2Pcs 1/2" Extension Bar:5",10" 2
 1Pcs 1/2" 3Way Adaptor 1
 1Pcs 5/16" X 1/2"Dr. Coupler 1
 17Pcs 5/16" Bit:Hex-7,8,10,12,14mm; REG-8,10,12mm; Philips:PH3,PH4; Pozi-PZ3,PZ4;Torx-T40,T45,T50,T55, T60 17
 1Pcs 1/2"Dr.Ratchet Handle:1/2" 1
 3Pcs Hex Key:1.5,2,2.5mm 3
 MEAS: 40X38X31 CM
 QTY: 4 SETS/CTN
 G.W: 29 KGS

715003



82 PCS TOOL SET

9pcs x combination wrench (8-10-11-12-13-14-17-19-22mm)
 12pcs x 1/2dr socket (14-15-16-17-18-19-20-21-24-27-30-32mm)
 13pcs x 1/4dr socket (4-4.5-5-5.5-6-7-8-9-10-11-12-13-14mm)
 1pc x adapter 1/4"
 1pc x adapter 1/2"
 2pcs x universal joint 1/2" & 1/4"
 2pcs x ratchet handle 24-tooth 1/2" & 1/4"
 1pc x spinner handle 1/4"
 2pcs x spark plug socket (16mm, 21mm)
 2pcs x sliding T-bar (1/4" & 1/2")
 2pcs x 1/4" extension bar 2" & 4"
 1pc x 1/2" extension bar 120mm
 1pc x 1/4" flexible extension bar
 15pcs x 30mm bits (H8-H10-H12-H14; (-)8-10-12; T40-T45-T50-T55; (+)PH3-PH4; PZ3-PZ4)
 17pcs x 1/4" bit socket T8-T10-T15-T20-T25-T30; PH1-PH2;
 PZ1-PZ2; (-)4-5.5-7; H3-H4-H5-H6)
 1pc x plastic box
 MEAS: 37 X 34 X 29 CM
 QTY: 4 SETS
 G.W: 24 KGS

715018



57 PCS TOOL SET

24pcs bit sockets
 13pcs 1/4 sockets 4-4.5-5-5.5-6-7-8-9-10-11-12-13-14
 6pcs E sockets 4-5-6-7-8-10
 4pcs 1/4 deep sockets 6-7-8-10
 1pc ratchet handle 1/4
 1pc 1/4 square handle
 5pc hex key
 2pc 1/4 extention bar
 1pc universal joint 1/4
 MEAS: 32X27X28 CM
 QTY: 10 SETS/CTN
 G.W: 15.6 KGS

715020



158 PCS TOOL SET

- 9 Pcs Allen Wrench
 - 10 Pcs wrench: 8,9,10,11,12,13, 14, 17, 18, 19mm
 - 3 Pcs ratchet spanner:12,13,14mm
 - 1 Pc slip joint pliers 8"
 - 1 Pc long nose pliers 6"
 - 4 Pcs screwdrivers: PH2*38mm, PH2*100mm, SL6*38mm, SL6*100mm
 - 10 Pcs 3/8" deep sockets: 8-9-1-11 -12-13-14-15-17-19mm
 - 10 Pcs 1/2" deep sockets:12-13-14 -15-16-17-18-19-21-22mm
 - 11 Pcs 1/4" deep sockets: 4-5-6-7 -8-9-10-11-12-13-14mm
 - 3 Pcs Ratchet handle 1/2&3/8&1/4
 - 14 Pcs bits
 - 15 Pcs bit sockets
 - 1 Pc adaptor
 - 1 Pc bit driver handle
 - 1 Pc holder
 - 2 Pcs spark plug sockets
 - 3 Pcs universal joint 1/2 &3/8 &1/4
 - 2 Pcs sliding bar
 - 4 Pcs extension bar
 - 14 Pcs 1/4 sockets:4-4.5-5-5.5 -6-6.5-7-8-9-10-11-12-13-14mm
 - 8 Pcs E-socket: E8-E10-E11 -E12-E14-E16-E18-E20
 - 12 Pcs sockets 3/8 DR: 8-9-10 -11-12-13-14-15-16-17-18-19mm
 - 15 Pcs sockets 1/2 DR:10-11 -12-13-14-17-18-19-20-21-22 -24-27-30-32mm
 - 4 Pcs Impact socket
- MEAS: 56x22x39 CM
QTY: 2 SETS/CTN
G.W: 27 KGS

715001



94 PCS TOOL SET

- 13-1/4" DR. 6PT. REG SOCKETS:4-4.5-5-5.5-6-7-8-9-10-11-12-13-14mm
 - 8-1/4" DR. 6 PT. DEEP SOCKETS:6-7-8-9-10-11-12-13mm
 - 3-1/4" DR. BIT SOCKETS: PH1-PH2
 - 2-1/4" DR. BIT SOCKETS: PZ1-PZ2
 - 4-1/4" DR. BIT SOCKETS: HW 3-4-5-6mm
 - 6-1/4" DR. BIT SOCKETS: TX8-10-15-20-25-30
 - 1-1/4" DR. SOCKET ADAPTER
 - 1-1/4" DR. RATCHET HANDLE 72-tooth
 - 2-1/4" DR. EXTENSION BAR 2"-4"
 - 1-1/4" DR. SLIDING T BAR
 - 1-1/4" DR. UNIVERSAL JOINT
 - 1-1/4" DR. SPINNER HANDLE
 - 1-1/4" DR. FLEXIBLE EXTENSION BAR
 - 18-1/2" DR. 6PT. REG. SOCKETS:10-11-12-13-14-15-16-17-18-19-20-21-22-23-24-27-30-32mm
 - 4-1/2" DR. 6PT. DEEP SOCKETS:14-15-17-19mm
 - 1-1/2" DR. RATCHET HANDLE 24-tooth
 - 1-1/2" DR. EXTENSION BAR 5"
 - 2-1/2" DR. SPARK PLUG SOCKETS 16-21mm
 - 1-1/2" DR. UNIVERSAL JOINT
 - 1-1/2" DR. 8mm HEXAGON BIT COUPLER
 - 1-3/8"Fx1/2" M 3 WAY ADAPTER
 - 3-HEX KEY WRENCH 1.5-2-2.5mm
 - 3-8mm BIT FD8-10-12mm
 - 2-8mm BIT PH3-PH4
 - 2-8mm BIT PZ3-PZ4
 - 4-8mm BIT HW8-10-12-14mm
 - 4-8mm BIT TX40-45-50-55
- MEAS: 38.5 X 28 X 31.5 CM
QTY: 4 SETS
G.W: 24 KGS

715021



148 PCS TOOL SET

- 9Pcs Allen Wrench
 - 10pcs wrench:8, 9, 10, 11, 12, 13, 14, 17, 18, 19mm
 - 3Pcs ratchet spanner:12,13,14mm
 - 1Pcs slip joint pliers 8"
 - 1Pcs long nose pliers 6"
 - 4Pcs screwdriver: PH2*38mm, PH2*100mm, SL6*38mm, SL6*100mm
 - 10Pcs 3/8 deep sockets:8-9-10-11 -12-13-14-15-17-19mm
 - 9Pcs 1/2 deep sockets: 12-13-14 -15-17-18-19-21-22mm
 - 9Pcs 1/4 deep sockets: 4-5-6-7-8 -9-10-11-12mm
 - 3Pcs Ratchet handle 1/2 ,3/8/ ,1/4
 - 14pcs bits
 - 15pcs bit sockets
 - 1pc adaptor
 - 1pc bit driver handle
 - 1pc holder
 - 2pcs spark plug sockets
 - 3pcs universal joint
 - 2pcs sliding bar
 - 4pcs extension bar
 - 10pcs 1/4 sockets: 4-5-5.5-6-6.5 -7-8-9-10-11-12mm
 - 8pcs E-socket: E8-E10-E11-E12 -E14-E16-E18-E20
 - 12pcs sockets 3/8 DR: 8-9-10-11 -12-13-14-15-16-17-18-19mm
 - 11Pcs sockets 1/2 DR: 14-17-18 -19-20-21-22-24-27-30-32mm
 - 4Pcs Impact socket:17-19-21-22mm
- MEAS: 56x22x39 CM
QTY: 2 SETS/CTN
G.W: 27 KGS

715004



121 PCS TOOL SET

- 10pcs combination wrench
 - 5pcs extension bar
 - 4pcs 1/4" deep socket
 - 6pcs 1/2" deep socket
 - 51pcs socket
 - 8pcs E-socket
 - 4pcs impact socket
 - 17pcs bit socket
 - 1pc spinner handle
 - 3pcs universal socket
 - 1pc adaptor
 - 7pcs bits
 - 3pcs ratchet handle
 - 1pc blow case
- MEAS: 48 X 36 X 21CM
QTY: 2 SETS
G.W: 18 KGS

715014



196 PCS TOOL SET

- 6pcs combination wrenches
 - 1pc tester pen
 - 4pcs precision screwdrivers
 - 3pc screwdrivers
 - 1pc bit driver handle
 - 1pc measure tape 5m
 - 1pc adjustable wrench
 - 1pc combination plier7
 - 1pc diagonal cutting pliers 6'
 - 1pc long nose plier6'
 - 8pcs hex key
 - 2pc clips
 - 2pc extension bar 1/2&1/4
 - 2pcs spark plug 16&21
 - 2pc universal joint 1/2&1/4
 - 1pc flash light
 - 1pcs 1/2 deep socket
 - 2pc ratchet handle1/2&1/4
 - 1pc water pump pliers
 - 1pc 8oz hammer
 - 1pc 1/4 handle
 - 1pc sliding T bar1/2
 - 30pcs bits
 - 60pcs hardware box
 - 31pcs bit box
 - 13pcs 1/4 dr socket
 - 16pcs 1/2 dr socket
 - 1pc 1/2 clasp
 - 1pc blow case
- MEAS: 54X39X26 CM
QTY: 2 SETS/CTN
G.W: 20 KGS

715005



171 PCS TOOL SET

- 30pcs bit socket
 - 5pcs 1/2" deep socket
 - 6pcs 3/8" deep socket
 - 7pcs 1/4" deep socket
 - 2pcs 1/2" extension bar
 - 1pc 1/2" sliding t-bar
 - 7pcs hex key wrench
 - 17pcs 1/2" socket
 - 3pcs ratchet handle
 - 13pcs e-socket
 - 24pcs bits
 - 10pcs 3/8" socket
 - 3pcs adapter
 - 13pcs 1/4" socket
 - 3pcs spark plug socket
 - 3pcs universal joint
 - 2pcs 1/4" extension bar
 - 1pc spinner handle
 - 20pcs bits with holder
 - 1pc blow case
- MEAS: 48 X 36 X 21CM
QTY: 2 SETS
G.W: 18 KGS

715006



216 PCS TOOL SET

13pcs 1/4" DR. 6PT. REG. METRIC SOCKETS: 4-4.5-5-5.5-6-7-8-9-10-11-12-13-14mm
 7pcs 1/4" DR. 6PT. DEEP SOCKETS: 4-5-6-7-8-9-10mm
 5pcs 1/4" DR. STAR SOCKETS: E4-E5-E6-E7-E8
 1pc 1/4" DR. RATCHET HANDLE
 2pcs 1/4" DR. EXTENSION BAR 2"-4"
 1pc 1/4" DR. UNIVERSAL JOINT
 1pc 1/4" DR. 1/4" HEXAGON BIT COUPLER
 1pc 1/4" DR. SPINNER HANDLE
 1pc 1/4" DR. SLIDING T BAR
 30pcs 1/4" DR. BIT SOCKET FD4-5-5.5-6-7
 PH1-2-3 PZ1-2-3 HW2-3-4-5-6-7-8-10
 TX8-10-15-20-25-27-30-40 M4-5-6
 10pcs 3/8" DR. 6PT. REG. SOCKETS: 10-11-12-13-14-15-16-17-18-19mm
 6pcs 3/8" DR. 6PT. DEEP SOCKETS: 10-11-12-13-14-15mm
 6pc 3/8" DR. STAR REG. SOCKETS: E10-E11-E12-E14-E16-E18
 1pcs 3/8" DR. RATCHET HANDLE
 1pc 3/8" DR. EXTENSION BAR 6"
 1pc 3/8" DR. SPARK PLUG SOCKET 21mm
 1pc 3/8" DR. UNIVERSAL JOINT
 1pc 3/8" Fx1/2" M ADAPTER
 1pc 3/8" DR. 8mm HEXAGON BIT COUPLER
 14pcs 1/2" DR. 6PT. REG. METRIC SOCKETS: 13-14-15-16-17-18-19-20-21-22-24-27-30-32mm
 5pcs 1/2" DR. 6PT. DEEP SOCKETS: 16-17-18-19-22mm
 3pcs 1/2" DR. STAR REG. SOCKETS: E20-E22-E24
 2pcs 1/2" DR. SPARK PLUG SOCKET 16-21mm
 1pc 1/2" DR. RATCHET HANDLE
 2pcs 1/2" DR. EXTENSION BAR 5"-10"
 1pc 1/2" DR. UNIVERSAL JOINT
 1pc 1/2" DR. 8mm HEXAGON BIT COUPLER
 2pcs 1/2" DR. BIT SOCKET TX55, 60
 30pcs 8mm BITS: FD6-6.5-8 PH3-4 PZ3-4 HW5.5-6-7-8 TX25-27-30-35-40-45-50-55 TTX27-30-35-40-45-50-55 M5-6-8-10
 3pcs HEX KEY WRENCHES: 1.5-2-2.5-mm
 50pcs 1/4" DR. BIT: TX8-9-10-15-20-25-27-30-40 TTX8-10-15-20-25-27-30-40 PH0-1-2-3- PZ0-1-2-3 FD3-4-5-6-7 HW1.5-2-2.5-3-4-5-5.5-6 M5-6 SQ0-1-2-3 SP4-6-8 TW1-2-3
 1pc MAGNETIC HEX KEY WRENCH
 12pcs COMBINATION WRENCH 8-9-10-11-12-13-14-15-16-17-18-19mm
 MEAS: 49 X 36 X 21CM
 QTY: 2 SETS
 G.W: 20 KGS

715007



141 PCS TOOL SET

22pcs hex key
 10pcs combination wrench
 40pcs bits with holder
 1pc ratchet bit handle
 16pcs 1/2" socket
 22pcs 1/4" socket
 8ps deep socket
 2pcs spark plug socket
 2pcs ratchet handle
 2pcs universal joint
 2pcs extension bar
 1pc spinner handle
 12pcs bit socket
 1pc blow case

MEAS: 37 X 34 X 29 CM
 QTY: 4 SETS
 G.W: 26 KGS

715008



55 PCS TOOL SET

6pcs combination wrenches
 5pcs screwdrivers
 1pc 6linesman plier
 1pc 8 water pump plier
 10pcs 1/2dr sockets
 1pc 1/2dr universal joint
 6pcs 1/4dr sockets
 18ncs bits 25mm
 1pc 300g hammer
 1pc 1/2dr extension bar
 1pc 1/4dr handle
 1pc 1/2dr ratchet handle
 2pcs spark plug sockets

QTY: 4 SETS/ CTN
 G.W: 22 KGS
 MEAS: 38X28X32 CM

715010



102 PCS TOOL SET

50 Sockets
 1 Adaptor
 1 Spark plug
 1 Extension bar
 1 Bit driver handle
 2 Ratchet handles 1/2" & 3/8
 22 Hex keys
 24 Bits

QTY: 6SETS/CTN
 GW: 16KGS
 N.W.: 15KGS
 MEAS: 42.5X32.5X24.5CM

715009



104 PCS TOOL SET

6pcs combination wrench
 60pcs bits
 2pcs extension bar 1/4&1/2
 2pcs ratchet handle 1/4&1/2
 1pc bit holder
 2pcs spark plug socket
 10pcs 1/4dr sockets
 6pcs 1/4dr deep socket
 14pcs 1/2dr socket
 1pc adapter

QTY: 4 SETS/ CTN
 G.W: 17 KGS
 MEAS: 36.5 X 32.5 X 31 CM

715011



107 PCS TOOL SET

1 Spark plug
 1 3/8" Extension bar
 1 3/8 Ratchet handle
 1 Bit driver handle
 35 Sockets
 1 Adaptor
 12 Spanners
 22 Hex keys
 33 Pcs bits

QTY: 6SETS/CTN
 GW: 16KGS
 N.W.: 15KGS
 MEAS: 42.5X32.5X24.5CM

715013



128PCS TOOL SET

- 1pc adaptar
 - 17pcs 1/2 metric sockets
 - 1pc 1/4 universal joint
 - 8pcs 1/4 depp sockets
 - 2pcs 1/2 spark plug 16&21mm
 - 5pcs 1/2 deep sockets
 - 1pc 1/4 spinner handle
 - 2pcs ratchet handle 1/2&1/4
 - 13pcs 1/4 metric sockets
 - 2pcs 1/4 extension bar 50&100mm
 - 1pc 1/4 T bar
 - 18pcs 1/4 bit sockets
 - 4pcs hex key
 - 2pcs 1/2 extension bar 125&250mm
 - 1pc extension sliding bar 3/8&1/2
 - 8pcs 1/2 E sockets
 - 5pcs 1/4 E sockets
 - 16pcs 5/16bits
 - 6pcs screwdrivers
 - 2pcs precision screwdrivers
 - 1pc water pump plier
 - 9pcs spanners
 - 1pc combination plier
 - 1pc long nose plier
 - 1pc blow case
- QTY:2SETS/CTN
GW:19.2KGS
MEAS:49.8X20.5X36.8MM

715016



57 PCS TOOL SET

- 21pcs 1/4dr bit socket
 - 7pcs 1/4dr deep socket
 - 13pcs 1/4dr socket
 - 1pcs 1/4dr soft extension bar
 - 9pcs hex key wrench
 - 1pc 1/4dr ratchet handle
 - 1pc 1/4dr spinner handle
 - 2pcs 1/4dr extension bar
 - 1pc universal joint
 - 1pc 1/4dr sliding T-bar
- QTY: 10 SETS/CTN
G.W: 18,3 KGS
MEAS: 36x27x31 CM

715015



140PCS TOOL SET

- 1 pc 1/2*10" L tpyle bar
 - 1 pc 1/2 universal joint
 - 1 pc set 3/8*6" extension bar
 - 1 pc set 1/2*16mm spark plug
 - 1 pc set 1/2*21mm spark plug
 - 9pcs 1/4 sockets 4-4,5-5-5,5-6-7-8-9-10mm
 - 5pcs 1/4 E sockets E4-5-6-7-8
 - 15pcs 3/8 sockets 6-7-8-9-10-11-12-13-14-15-17-18-19-21-22mm
 - 5pcs 1/2 E sockets E10-E12-E14-E16-E20
 - 19pcs 1/2 sockets 8-9-10-12-13-14-15-16-17-18-19-20-21-22-23-24-27-30-32mm
 - 1pc 1/4*6 square handle
 - 1pc 1/2*3 extension bar
 - 1pc 1/4*6 extension bar
 - 1pc 1/4*150mm soft bar
 - 1pc 1/2*10 sliding bar
 - 1pc 1/2*17 F bar
 - 1pc 1/4*2 extension bar
 - 1pc 1/4*4 extension bar
 - 1pc 3/8*3 extension bar
 - 2pc 1/4&3/8 universal joint
 - 1pc 300g fitter hammer
 - 10pcs hex key 2.5-3-4-5-6-7-8-10-12-14mm
 - 5pcs double open spanners 8x9, 10x11, 12x13, 14x15, 18x19
 - 17pcs combination spanners 6-7-8-9-10-11-12-13-14-15-16-17-18-19-20-21-22mm
 - 6pcs screwdrivers PH2*38mm, SL6*38mm, PH2*100mm, SL6*100mm, PH2*150mm, SL6*150mm
 - 1pc 7' cutting plier
 - 1pc 10' locking plier
 - 3pcs ratchet handle 1/4&3/8&1/2
 - 26pcs 25mm deep bits PH0-PH1-PH2-PH3-PH4-PZ0-PZ1-PZ2-PZ3-PZ4-S0-S1-S2-S3-S4-SL3-SL4-SL5-SL6-T5-T6-T8-T10-T15-T20-T25
 - 1pc holder
- QTY:8SETS/CTN
GW:13.5KGS
MEAS:50X24X30.5CM

715017



46 PCS TOOL SET

- 13pcS-1/4" DR
 - SOCKETS:44,5,5,5,5,6,7,8,9,10,11,12,13,14MM
 - 21pcs bit sockets
 - 3pcs-HEX KEY wrench
 - 1pc 1/4 DR universal joint
 - 1pcs 1/4dr extension bar
 - 1pc universal joint
 - 1pc 1/4dr sliding T-bar
 - 1pc 1/4dr ratchet handle
 - 1pc 1/4dr spinner handle
 - 1pc adaptor
 - 1pc Flexible Extension bar
- QTY: 16 SETS/CTN
G.W: 25 KGS
MEAS: 42x29x50 CM

715012



187PCS TOOL SET

- 1/4"-64pcs:
 - 13pcs socket:4,4,5,5,5,5,6,7,8,9,10,11,12,13,14 mm
 - 7pcs deep socket:4,5,6,7,8,9,10 mm
 - 5pcs E-socket:E4,E5,E6,E7,E8
 - 33pcs bit socket:H3-H4-H5-H6;PHO-PHO-PH1-PH1-PH2-PH2;FD4-FD5.5-FD6.5-FD7;T8-T9-T10-T15-T20-T25-T27-T30;TTX8-TTX9-TTX10-TTX15-TTX20-TTX25-TTX27-TTX30; M8-M10-M12
 - 2pcs extension bar2 &4
 - 1pc ratchet handle
 - 1pc universal joint
 - 1pc sliding bar
 - 1pc spinner handle
 - 3/8"-27pcs:
 - 10pcs socket:10,11,12,13,14,15,16,17,18,19 mm
 - 6pcs deep socket: 10,11,12,13,14,15 mm
 - 1pc spark plug socket :18mm
 - 6pcs E-socket: E10,E11,E12,E14,E16,E18
 - 1pc extension bar125mm(5)
 - 1pc ratchet handle
 - 1pc universal joint
 - 1pc Adapter 3/8"x5/16"
 - 1/2"-32pcs:
 - 17pcs socket:10,11,12,13,14,15,16,17,18,19,20,21,22,24,27,30 e 32 mm
 - 2pcs E-socket: E20 e E24
 - 2pcs extension bar125mm(5"), 250mm (10")
 - 1pc ratchet handle
 - 1pc three-way adapter
 - 1pc universal joint
 - 1pc adapter 1/2"x5/16"
 - Bits 5/16"-24pcs:
 - 5pcs Bits hexagonais:7,8,10,12, 14 mm
 - 4pcs Bits fenda cruzada: PH3 (x2), PH4 (x2)
 - 3pcs Bits fenda simples: 8,10, 12 mm
 - 6pcs Bits GTX(perfil hexalobular): T40,T45,T50.T55.T60 eT70
 - 6pcs Bits GTX com guia (perfil hexalobular): TTX40,TTX45,TTX50,TTX55,TTX60, TTX70
 - Wrenches-30pcs:
 - 9pcs hex key wrench (ball head): 1,5,2,2,5,3,4,5,6,8,10 mm
 - 9pcs hex key wrench (T.head): T10,T15,T20,T25T27.T30.T40,T45, T50
 - 12pcs ratchet combination wrench: 8,9,10,11,12,13,14,15,16,17,18 ,19 mm
 - Plastic box-1pc
 - 2pcs deep socket:16,18 mm
 - 3pcs impact socket: 17,19,21 mm
 - 2pcs spark plug socket:16,21 mm
- MEAS: 48.5X20X35.5 CM
QTY: 2 SETS/CTN
G.W: 24 KGS

715019



16 PCS TOOL SET

- 12PCS SOCKETS 19-21-22-24-27-30-32-36-38-41-46-50MM
 - 2PCS EXTENSION BARS
 - 1PCS ADAPTAR 3/4&1/2
 - 1PC RETRACTABLE RATCHET HANDLE
- QTY:1SETS/CTN
GW:12KGS
MEAS:51.3X33X10CM

715103



26 PCS TOOL SET

17pcs 3/4" DR SOCKETS:21mm-22mm-23mm-24mm
-26mm-27mm28mm-29mm-30mm-31mm-32mm
-34mm-36mm-38mm-41mm-46mm-50mm;
3pcs 1"DR SOCKETS:55mm,60mm,65mm
1pc 3/4"sliding rod
1pc 3/4" to 1"Adapter
1pc 3/4" bending rod
1pc 3/4"extension bar
1pc 3/4"ratchet wrench head
1pc 3/4 "force rod

QTY:1SETS/CTN
GW:18KGS
N.W.:17.5 KGS
MEAS:55.5X31.5X12.5CM

715102



32 PCS TOOL SET

20PCS 1/2 DR SOCKETS:8 9-10-11-12-13-14-15-16-17-18
-19-20-21-22-23-24-27-30- 32
9PCS DEEP SOCKETS:10-12-13-14-17-19-21-22-24
1PC 1/2 EXTENSION BAR
1PC 1/2 UNIVERSAL JOINT
1PC blow case

QTY: 5 SETS/CTN
G.W: 25 KGS
MEAS: 40x39x31 CM

715101



16 PCS 1/2DR IMPACT SOCKET

16pcs 1/2dr impact socket:
10-11-12-13-14-15-16-17-18-19
21-22-24-27-30-32mm

QTY: 4 SETS/CTN
G.W: 18 KGS
MEAS: 36.5x30.3x28.5 CM

715104



8 PCS TOOL SET

1 x 1/4" Adaptor Female 3/8" Male x 27mm
1 x 3/8" Adaptor Female 1/4" Male x 28mm
1 x 3/8" Adaptor Female 1/2" Male x 38mm
1 x 1/2" Adaptor Female 3/8" Male x 38mm
1 x 1/2" Adaptor Female 3/4" Male x 49mm
1 x 3/4" Adaptor Female 1/2" Male x 57mm
1 x 3/4" Adaptor Female 1" Male x 60mm
1 x 1" Adaptor Female 3/4" Male x 70mm

QTY:10SETS/CTN
GW:14.8KGS
N.W.: 14KGS
MEAS:32X20X32CM

715105



11 PCS TOOL SET

1 x1/4"Adaptor Female 3/8"Male
1 x3/8" Adaptor Female 1/4 Male
1 x3/8" Adaptor Female 1/2 Male
1 x1/2"Adaptor Female 3/8" Male
1 x1/2"Adaptor Female 3/4" Male
1 x3/4"Adaptor Female 1/2"Male
1 x3/4"Adaptor Female 1 Male
1 x1"Adaptor Female 3/4 Male
3pcs x Universal adaptor 1/4"&3/8"&1/2"

QTY:10SETS/CTN
GW:19.5KGS
N.W.:19 KGS
MEAS:39X28X33CM

715107



35PCS 1/2" DR PNEUMATIC SOCKET

Short socket:8,9,10,11,12,13,14,15,16,
17,18,19,20,21,22,23,24,27,30,32mm
Deep socket:10,12,13,14,15,16,17,18,
19,21,22,24,27,30,32mm

MEAS: 45X19X22 CM
QTY: 4 SETS
G.W: 22 KGS

717302



56PCS TOOL SET

18pcs 1/2 dr sockets:8-10-12-13-14-15-16-17-18-19-20-21-22-23-24-27-30-32mm
 1pc 1/2 ratchet handle
 2pc 1/2 5"10" extention bar
 1pc universal joint 1/2
 2pc spark plug 16/21mm
 1pc 1/2 F bar
 9pcs hex key
 5pcs screwdrivers
 1pc combination plier 6'
 1pc diagonal cutting plier 6'
 1pc 8' adjustable wrench plier
 1pc long nose plier 6'
 1pc locking plier 10'
 12pcs spanner 8-10-11-12-13-14-15-16-17-18-19-22

MEAS: 53X23X23 CM
 QTY: 1 SETS/CTN
 G.W: 13 KGS

717301



85 PCS TOOL SET

18pcs 3/8 sockets
 1pc 3/8 ratchet handle
 1pc knife
 1pc combination plier6'
 1pc long nose plier6'
 1pc measure tape 5m
 1pc water pump plier
 1pc locking plier
 9pcs hex key
 10pcs spanners
 5pcs screwdrivers
 1pc 1/4 extension bar
 1pc bit driver handle
 3/8 extension bar
 12pc 1/4 sockets
 6pcs bits
 1pc 1pc universal joint

1pcs T bar
 1pc 1/4 ratchet handle
 1pc iron box

QTY:1SETS/CTN
 GW:12.5KGS
 MEAS:51X24X24CM

717303



33 PCS TOOL SET

12pcs x 1/4" socket (4-5-5.5-6-7-8-9-10-11-12-13-14MM)
 12pcs x 1/4" bit socket (T10-T15-T20-T25-T30-T40; PH1-PH2; H3-H4-H5-H6)
 3pcs x hex key wrench (1.5-2-2.5MM)
 1pc x 1/4" ratchet handle
 1pc x 1/4" spinner handle
 2pcs x 1/4" extension bar (5CM & 10CM)
 1pc x 1/4" universal joint
 1pc x 1/4" sliding T-bar

QTY:18SETS/CTN
 GW:23.5KGS
 MEAS:41x25.8x26.5CM

717305



24PCS 1/2"DR.SOCKET SET

18Pcs 1/2"DR.Hexagon Socket:10,11,12,13,14,15,16,17,18,19,20,21,22,23,24,27,30,32mm
 1Pcs1/2" Universal Joint
 2Pcs 1/2" Extention Bar:5";10"
 1PCS 1/2" T Handle Sliding Bar
 1Pcs 1/2"Spark Plug Socket:21mm
 1Pcs 1/2" Ratchet Wrench

MEAS: 47X21X23 CM
 QTY: 4 SETS/CTN
 G.W: 20 KGS

717303



24PCS 1/2"DR.SOCKET SET

18Pcs 1/2"DR.Hexagon Socket:10,11,12,13,14,15,16,17,18,19,20,21,22,23,24,27,30,32mm
 1Pcs1/2" Universal Joint
 2Pcs 1/2" Extention Bar:5";10"
 1PCS 1/2" T Handle Sliding Bar
 1Pcs1/2" F Handle:15"
 1Pcs 1/2" Ratchet Wrench

MEAS: 47X21X23 CM
 QTY: 4 SETS/CTN
 G.W: 23 KGS

717304



24PCS 1/2"DR.SOCKET SET

18Pcs 1/2"DR.Hexagon Socket:10,11,12,13,14,15,16,17,18,19,20,21,22,23,24,27,30,32mm
 1Pcs1/2" Universal Joint
 2Pcs 1/2" Extention Bar:5";10"
 1PCS 1/2" T Handle Sliding Bar
 1Pcs1/2" F Handle:15"
 1Pcs 1/2" Ratchet Wrench

MEAS: 47X21X23 CM
 QTY: 4 SETS/CTN
 G.W: 22 KGS

717306



24PCS 1/2"DR.SOCKET SET

18Pcs 1/2"DR.Hexagon Socket:10,11,12,13,14,15,16,17,18,19,20, 21,22,23,24,27,30,32mm
 1Pcs1/2" Universal Joint
 2Pcs 1/2" Extention Bar:5";10"
 1PCS 1/2" T Handle Sliding Bar
 1Pcs1/2" Speeder Handle
 1Pcs 1/2" Ratchet Wrench

Carton Dimension: 47X21X23 CM
 Carton Quantity: 4 SETS/CTN
 G.W: 22 KGS

717051



12PCS 3/8" SOCKETS SET

8,10,11,12,13,14,15,16,17,19mm

715151



10PCS 1/2" DR PNEUMATIC SOCKET

10,12,13,14,15,17,19,21,22,24mm

717052



12PCS 1/4" SOCKETS SET

5,6,7,8,9,10,11,12,13,14mm

715152



10PCS 1/2" DR DEEP PNEUMATIC SOCKET

10,12,13,14,15,17,19,21,22,24mm

717053



12PCS 1/2" SOCKETS SET

10,12,13,14,15,17,19,21,22,24mm

717201



100 PCS TOOL SET

- 1pc 6" long Nose plier,
- 1pc 6" combination plier,
- 1pc 6" diagonal plier,
- 1pc 4.5" long Nose plier,
- 1pc 4.5" diagonal plier
- 1pc 6" adjustable wrench
- 16pcs sockets :5-12mm,3/16-15/32
- 12pcs 3/8 sockets, :11-17mm,7/16-11/16mm
- 1pc spark plug sockets, 21mm
- 1pc 1/4 and 3/8 adapter,
- 1pc 3/8 x 3" extension bar,
- 1pc 3/8 drive ratchet wrench,
- 1pc bit driver handle,
- 30pcs bits
- 1pc holder
- 1pc driver disk
- 1pc 7"locking Pliers,
- 1pc knife,
- 6pcs combination wrenches
- 1pc tester with wire clips
- 4pcs screwdrivers
- 1pc crimping plier
- 6pcs precision screwdrivers
- 8pcs hex keys
- 1pc blow case

QTY:2SETS/CTN
 GW:13.5KGS
 MEAS:40X26X46MM

717202



154 PCS TOOL SET

- 16pcs hex key wrenches
- 12pcs 3/8dr sockets
- 1pc 3/8dr ratchet handle
- 1pc 3/8dr extension bar
- 1pc spark plug socket
- 1pc 6"adjustable wrench
- 1pc 3/8&1/4 adapter
- 9pcs 1/4dr sockets
- 1pc level
- 1pc 8oz claw hammer
- 1pc ele.Tester
- 79pcs Assortment fasteners in a plastic box
- 1pc scissors
- 1pc insulation tape
- 2pcs screwdrivers
- 1pc measure tape 5m
- 1pc bit driver handle
- 20pcs bits
- 1pc 6"diagonal cutting plier
- 1pc 6" long nose plier
- 1pc 6" slip joint plier
- 1pc knife

QTY:1 SET/CTN
 G.W.:9 KGS
 MEAS:35X23X29CM

717209



72 PCS TOOL SET

- 1pc 9" level
- 1pc magnetic extension rod
- 30pcs 25mm bits sets :
 (+)0-1-2-3, (-)2-3-4-5-6-7;(*)0-1-2-3, H2-3-4-5-6-7S0-S1
 -S2-S3-T10-T15-T20-T25-T30-T40
- 10pcs 50mm bits set :PHO-PH1-PH2-PH3.(-)4-5-6,
 T15-T20-AD
- 1pc 25mm AD
- 8pcs hex key 1/16-5/64-3/32-1/8-5/32-3/16-7/32-1/4
- 6pcs woodworking drill,3-4-5-6-7-8mm
- 1pc universal flexible shaft
- 9pcs 1/4 sockets 5-6-7-8-9-10-11-12-13mm
- 1pc 8oz hammer
- 1 set 12V electric drill
- 1pc 6"long nose plier
- 1pc 3m measure tape

MEAS: 40X33X31 CM
 QTY: 4 SETS/CTN
 G.W: 13 KGS

717204



26 PCS CANE WRENCH SET

- 12pcs T30X150 T27X150 T25X150 T20X100 T15X100 T10X75
 H2X100 H2.5X100 H3X100 H4X150 H5X150 H6X150
- 14pcs screwdrivers(-)5x75 5x100 6x100 6x125 6x150
 8x200(+)5x75 5x100 6x100 6x125 6x150 8x200

MEAS: 48X40X35 CM
 QTY: 4 SETS/CTN
 G.W: 18 KGS

717203



82 PCS TOOL SET

- 6pcs screwdrivers
- 5pcs precision screwdrivers
- 1pc bit driver handle
- 1pc holder
- 1pc adapter
- 1pc 1/4 ratchet handle
- 1pc water pumping pliers
- 12pc sockets 1/4
- 1pc level
- 1pc combination pliers
- 1pc long nose pliers
- 9pc hex key
- 1pc measure tape
- 1pc 12oz hammer
- 40pcs bits

MEAS: 40X36X30 CM
 QTY: 4 SETS/CTN
 G.W: 13 KGS

717215



79 PCS TOOL SET

- 20pcs bits
 - 1pc bit driver handle
 - 5pcs precision screwdrivers
 - 1pc scissor
 - 1pc slip joint pliers
 - 1pc knife
 - 10pcs knife blades
 - 1pc level
 - 10pcs sockets 1/2,7/16,3/8,11/32,5/16,9/32,1/4,7/32,3/16,5/32
 - 10pcs metric sockets 5-6-7-8-9-10-11-12-13-14
 - 1pc 1/4 ratchet handle
 - 1pc extension bar
 - 1pc 12oz hammer
 - 1pc diagonal cutting pliers
 - 1pc long nose pliers
 - 1pc measure tape 3m
 - 1pc adjustable wrench
 - 12pcs bit sockets
- MEAS: 39X35X33 CM
QTY: 4 SETS/CTN
G.W: 16.5 KGS

717206



45 PCS TOOL SET

- 24pcs bits
 - 1pc scissors
 - 1pc bit driver handle
 - 2pcs precision screwdriver
 - 1pc bit extension bar
 - 1pc knife
 - 9pcs 1/4dr sockets
 - 1pc 6" adjustable wrench
 - 1pc 8oz claw hammer
 - 1pc 8linesman plier
 - 1pc ele. tester
 - 1pc measure tape 3m
 - 1pc insulation tape
- QTY:5 SETS/CTN
GW:10 KGS
MEAS:30X22X33CM

717223



48 PCS TOOL SET

- 16pcs Hex Key
 - 1pc Bit holder
 - 1pc 6" slip joint pliers
 - 2pcs precision screwdrivers
 - 2pcs screwdrivers:(+/-)1/4*4'
 - 20pcs bits
 - 1pc extension bar
 - 1pc adjustable wrench
 - 1pc 8 OZ claw hammer
 - 1pc scissor
 - 1pc knife
 - 1pc measure tape 3M/10ft
- MEAS: 54X36X30 CM
QTY: 6 SETS/CTN
G.W: 18.5 KGS

717208



57 PCS TOOL SET

- 2 pcs precision screwdrivers
 - 2 pcs screwdrivers
 - 1 pc bit holder
 - 1 pc saw
 - 1 pc knife
 - 10pcs blades
 - 16 pcs bits
 - 1 pc 8 OZ claw hammer
 - 12 pcs sockets
 - 1 pc ratchet handle
 - 1 pc 6" linesman plier
 - 1 pc water pump plier
 - 1 pc measure tape
 - 9 pcs hex key
- QTY:5 SETS/CTN
G.W:15 KGS
MEAS:37x40x31CM

717224



128 PCS TOOL SET

- 1pc 8oz Claw Hammer
 - 1pc 6inch Cutting Pliers
 - 1pc 8inch Adjustable Wrench
 - 1pc 6inch Utility Knife
 - 1pc 10feet Tape Measure
 - 1pc 16feet PVC Insulating Tape
 - 1pc 1/4inch Magnetic Bit Driver
 - 1pc 1/4inch Bit Connector
 - 1pc Wood Screws Assortment Kit
 - 1pc Mini Dual-Head Ratchet Screwdriver
 - 2pcs 4inch Screwdrivers Phillips 6.0mm, Slotted 6.0mm
 - 4pcs Precision Screwdrivers Phillips 3.0mm, 2.4mm; Slotted 3.0mm, 2.4mm
 - 8pcs Metric Hex Keys 1.5mm,2mm,2.5mm, 3mm, 4mm, 5mm, 5.5mm, 6mm
 - 8pcs SAE Hex Keys 1/16", 5/64", 3/32",1/8",5/32", 3/16", 7/32", 1/4"
 - 9pcs 1/4inch Driver Sockets 5mm, 6mm, 7mm, 8mm, 9mm, 10mm, 11mm, 12mm,13mm
 - 30pcs Screwdriver Bits
 - 58pcs-Wood screws assortment
- MEAS: 39X35X33 CM
QTY: 4 SETS/CTN
G.W: 16.5 KGS

717109



242 PCS TOOL SET

- 6pcs precision screwdriver
 - 1pc 6" long nose pliers
 - 1pc 6" diagonal cutting pliers
 - 1pc 6" combination pliers
 - 2pcs screwdriver
 - 1pc knife
 - 1pc level
 - 1pc 8oz claw hammer
 - 100pcs assortment fasteners in a plastic box
 - 24pcs hex key wrench
 - 1pc bit holder
 - 1pc punch
 - 2pcs plastic articles
 - 24pcs 1/4dr sockets
 - 40pcs bits
 - 1pc extension bar
 - 7pcs bit sockets 5-6-7-8-9-10-11mm
 - 26pcs drills
 - 2pcs adapter
 - 1pc blow case
- MEAS: 51x40.5x32.5 CM
QTY: 5 SETS
G.W : 19.5 KGS

717212



121 PCS TOOL SET

- 1 pcs bit handle
 - 4 pcs Screwdriver: (+/-) 5*75mm, 6*100mm
 - 30 pcs bits
 - 50pcs Fastening accessories
 - 1 pc level
 - 1 pcs 10" Water Pump Pliers
 - 9pcs sockets : 4-5-6-7-8-9-10-11-12mm
 - 1 pc ratchet handle
 - 1 pcs Tape 3m
 - 9pcs Hex Keys: 1.5-2-2.5-3-4-5-6-8-10mm
 - 1pc 6"combination plier
 - 1pc 6"diagonal cutting pliers
 - 1 pc Knife
 - 10pcs blade
 - 1 pc 8 OZ Claw Hammer
- QTY:4SET/CTN
G.W:15.5KGS
MEAS:35.5X40X31CM

717221



172 PCS TOOL SET

- 10pcs combination wrenches:8-9-10-11-12-13-14-15-17-19mm
 - 1pc 6" combination plier
 - 1pc 6" long nose plier
 - 30PCS BIT SET:25MM
 - (+) PH0-PH1-PH2-PH3, (-) S2-S3-S4-S5-S6-S7;
 - (*) PZ0-PZ1-PZ2-PZ3, H2-H3-H4-H5-H6-H7;
 - S0-S1-S2-S3-T10-T15-T20-T25-T30-T40,
 - 13pcs 1/4DR sockets4-4.5-5-5.5-6-7-8-9-10-11-12-13-14mm
 - 10pcs 1/2DR sockets10-11-12-13-14-17-19-22-24-27mm
 - 1pc 10"water pump plier
 - 2pcs 1/4&1/2 ratchet handle
 - 2pcs 1/4 2"&4" extension bar
 - 1pc 1/2 universal joint
 - 2pcs spark plug socket16&21mm
 - 1pc 1/4 bit handle
 - 8pcs hex key wrench1.5-6mm
 - 90pcs hardwares in a plastic box
- QTY:4SETS/SET
G.W:21KGS
MEAS:39.5x30x34CM

717213



156 PCS TOOL SET

- 4pcs screwdrivers
 - 1pc bit driver handle
 - 1pc measure tape 3m
 - 5pcs precision screwdrivers
 - 4pcs plastic clips
 - 60pcs assortment fasteners in a plastic box
 - 1pc level
 - 1pc 3/8dr ratchet handle
 - 1pc 3/8dr extension bar
 - 1pc 3/8dr spark plug socket
 - 6pcs combination wrenches
 - 1pc3/8&1/4 adapter
 - 12pcs 1/4dr sockets
 - 10pcs 3/8dr sockets
 - 1pc bit extension bar
 - 1pc insulation tape
 - 1pc hack saw
 - 9pcs hex key wrenches
 - 10pcs bits 50mm
 - 20pcs bits 25mm
 - 1pc knife
 - 1pc 6"linesman plier
 - 1pc 6" long nose plier
 - 1pc 6" adjustable wrench
 - 1pc 8 water pump plier
 - 1 pc6" crimping plier
 - 1pc 8oz claw hammer
- QTY:2 SETS/CTN
G.W:12 KGS
MEAS:46X19X36CM

717216



105 PCS TOOL SET

- 8pcs hex key
 - 1pc 6"long nose plier
 - 1pc 6"combination plier
 - 1pc 5m tape
 - 9pcs 1/4 sockets
 - 1pc flash light
 - 1pc 8oz hammer
 - 1pc 8' adjustable wrench
 - 60pcs hardware box
 - 4pcs precision screwdrivers
 - 1pc saw
 - 1pc tester pen
 - 10pcs bits
 - 1pc knife
 - 2pc screwdrivers
 - 1pc 3m measure tape
 - 1pc T bar
 - 1pc blow case
- QTY:4SETS/CTN
GW:11KGS
MEAS:37X34X30CM

717214



299 PCS TOOL SET

- 1x flexible extension bar 270mm
 - 2x wrenches
 - 1x scissors 8"
 - 2x screwdriver (PH2X100mm, SL6X100mm)
 - 1x tester
 - 240x nails in a plastic box
 - 1x knife
 - 1x wire stripper 6.5"
 - 1x 6" long nose pliers
 - 1x 6" combination pliers
 - 11x drills (glass drill 5-6mm; twist drill 5-6-8mm; masonry drill 5-6-8mm; wood drill 5-6-8mm)
 - 1x hand saw 6"
 - 9x 1/4"DR socket 5-6-7-8-9-10-11-12-13mm
 - 1x bit holder
 - 1x level 6"
 - 1x claw hammer 8OZ
 - 1x PVC tape 5M
 - 10x bits 50MM PH1-PH2-PH3 -PZ1-PZ2-SL5-SL6-T20-T25-AD
 - 8x hex key wrench 1.5-6
 - 1x measure tape 3M
 - 1x cordless drill without impact function 21V, 1300mAH
 - 1x charger
 - 1x battery
 - 1x blow mold case
- QTY:3SETS/CTN
GW:19.5KGS
MEAS:52.5X40X39CM

717217



42 PCS TOOL SET

- 1pc adjustable wrench 6"
 - 1 pc 8oz claw hammer
 - 1 pc 6" long nose plier
 - 1 pc 6" slip joint plier
 - 1 pc scissor
 - 1 pc driver handle
 - 10 pcs bits
 - 1 pc measure tape 3m
 - 2 pcs precision screwdrivers
 - 12 pcs HEX key wrench
 - 9 pcs 1/4dr. Sockets
 - 1 pc knife
 - 1 pc level
- QTY: 6SETS/SET
G.W: 15 KGS
MEAS: 34.3x28x52.5 CM

717218



9 PCS TOOL SET

- 1pc knife
- 1pc 5m tape
- 1pc tester pen
- 2pc screwdrivers
- 1pc 6' combination plier
- 1pc min-hammer
- 1pc 3m measure tape
- 1pc blow case

QTY:20SETS/CTN
 GW:20KGS
 MEAS:37.5X26X62MM

717219



39 PCS TOOL SET

- 8pcs hex key
- 1pc 6' combination plier
- 1pc bit driver handle
- 4pcs precision screwdrivers
- 20pcs bits
- 1pc level
- 1pc extension bar
- 1pc 8oz hammer
- 1pc scissor
- 1pc 3m measure tape
- 1pc blow case

QTY:8SETS/CTN
 GW:12.5KGS
 MEAS:39X33X34.5MM

717220



46 PCS TOOL SET

- 1 pc 6" diagonal plier
- 1 pc 6" long nose plier
- 1 pc 6" slip joint plier
- 1pc adjustable wrench
- 5 pcs precision screwdrivers
- 1 pc level
- 1 pc 8oz claw hammer
- 1 pc measure tape 5m
- 1 pc bit driver handle
- 32 pcs bits
- 1 pc extension bar
- 1 pc knife

QTY: 6 SETS/CTN
 G.W: 15 KGS
 MEAS: 47x37x27 CM

717222



203 PCS TOOL SET

- 4pcs precision screwdrivers
- 4pcs screwdrivers (+-) 5x75, (-) 6x100
- 22 pcs hex wrench
- 1pc 6"long nose plier
- 1pc6' diagonal cutting plier
- 1pc 6" slip joint plier
- 1pc 6"adjustable plier
- 2 pcs clips
- 1 pc oil knife
- 1 pc saw
- 1 pc knife
- 10 pcs blade
- 1 pc measure tape 3m
- 60 pcs hardware in a box
- 1 pc level
- 1 pc bit handle
- 1 pc hammer
- 1 pc extension bar
- 9 pcs sockets
- 80 pcs bits

QTY: 4 SETS/CTN
 G.W: 21 KGS
 MEAS:47.5x37.5x39.5 CM

717205



21 PCS CHISEL TOOL SET

- 20pcs chisels
- 1pc 12oz hammer

QTY:4SETS/CTN
 GW:19.4KGS
 MEAS:40.5X39X34.5MM

717505



15 PCS FLEXIBLE RATCHET COMBINATION WRENCH SET

6-7-8-10-12-13-14-17-19-21-22-24-27-30-32MM

QTY:2SET/CTN
GW:13KGS
MEAS:44X16.5X38CM

717502



22 PCS FLEXIBLE RATCHET COMBINATION WRENCH SET

6-7-8-9-10-11-12-13-14-15-16-17-18-19-20-21-22-23-24-27-30-32

QTY:2SET/CTN
GW:16KGS
MEAS:61.5X14.5X34CM

717503



19 PCS PERFORATED L WRENCH SET

6,7,8,9,10,11,12,13,14,15,16,17,18,19,22,24,27,32,30mm

QTY:2SET/CTN
GW:19KGS
MEAS:47X36X21CM

717501



22 PCS FLEXIBLE RATCHET COMBINATION WRENCH SET

6-7-8-9-10-11-12-13-14-15-16-17-18-19-20-21-22-23-24-27-30-32

QTY:2SET/CTN
GW:16KGS
MEAS:61.5X14.5X34CM

717504



13 PCS FLEXIBLE RATCHET COMBINATION WRENCH SET

8-10-12-13-14-17-19-21-22-24-27-30-32 MM

QTY: 2 SETS/CTN
G.W: 14 KGS
MEAS: 47.5 x 20.5 x 35 CM

717506



25 PCS COMBINATION WRENCH SET

6-7-8-9-10-11-12-13-14-15-16-17-18-19-20-21-22-23-24-25-26-27-28-30-32mm

QTY: 4SETS/CTN
G.W :23.5KGS
MEAS : 51X18X18CM

717531



8PCS COMBINATION SPANNER SET

8,10,12,13,14,15,17,19mm

717534



14PCS COMBINATION SPANNER SET

6,7,8,10,12,13,14,17,19,22,24,27,30,32mm

717532



10PCS COMBINATION SPANNER SET

8,9,10,11,12,14,15,17,19,22mm

717535



12PCS DOUBLE OPEN END WRENCH SET

6x7,8x9,10x11,12x13,14x15,16x17,18x19, 20x22,21x23,24x27,25x28,30x32mm

717533



12PCS COMBINATION SPANNER SET

6,7,8,9,10,11,12,13,14,17,19,22mm

717536



12PCS OFFSET RING SPANNER SET

6x7,8x9,10x11,12x13,14x15,16x17,18x19, 20x22,21x23,24x27,25x28,30x32mm

715201



112 PCS SCREW TAP TOOL SET

- 2pcs tap holder
- 70pcs taper taps
- 2pcs die holder
- 35pcs die
- 2pc T-bar tap wrench

QTY:2 SETS/CTN
G.W. :12.5KGS
MEAS: 45x34x8.5CM

715202



20PCS TAPS & DIES

- 1pc die holder
- 1pc die
- 1pc min-screwdriver
- 1pc T-bar tap wrench
- 1pc tap holder
- 20pcs taper taps

QTY:2 SETS/CTN
G.W. :10KGS
MEAS: 45x34x8.5CM

715203



17 PCS HYDRAULIC RAM SET

- 1 pc bearing separator
- 1 pc beam
- 1 pc centre adapter
- 1 pc triple head
- 1 pc twin head
- 3 pcs 4"leg puller
- 3 pcs 6"leg puller
- 3 pcs 8"leg puller
- 1 pc ram part
- 1 pc 2" extension rod
- 1 pc 10 tonne hydraulic ram and 3xscrew.

QTY:4 SETS/CTN
G.W. :20 KGS
MEAS: 54x40x38 CM

715204



24PCS PRESS AND PULL SLEEVE KIT

- 20 x press-on sleeves
- Inside: Diameter 34,36,38,40,42,44,46,48,50,52,54,56,58,60, 62,64,66,68,70, 72 mm
- Outside: Diameter 44, 46, 48,50,52,54, 56,58,60, 62, 64,66, 68, 70, 72,74,76,78,80, 82mm
- 4 x pulling spindle + nuts
- Sizes: M10, M12, M14, M16

QTY:1 SETS
G.W. 17.5 KGS
MEAS: 47 X 42X 12 CM

715205



DIESEL INJECTOR EXTRACTOR MASTER KIT

- A master injector extractor kit for removal of diesel injectors. With various adaptors make the kit suitable for most diesel injectors.
- Pulling claws with fork opening 13.7x18mm,12.7x19mm.
- Slotted 1/2" Drive sockets,6pt,100mm long 25/27/28/29/30mm.
- Sleeve design injector extractor with supporting shells, diameter35mm, internal dia29mm, M17x 1.0 spindle.
- Pulling adapter with external thread M27x 1.0(3pcs)and M25x 1.0.
- Pulling adapter with internal thread M27x 1.0(3pcs).
- Sliding hammer adapter for inner, outer and claw extractor.
- Pulling claws with fork opening 13.7x18mm,105mm , 12.7x19mm,130mm long

QTY: 1 SETS
G.W.22 KGS
MEAS:63x 11x 40 CM

715206



21PCS PNEUMATIC PULLER FOR INJECTOR

- Tool for disassembly of especially tight injection nozzles and glow plugs. Comes complete with a universal adaptor set that cover Bosch,Delphi, denso,Siemens CR injectors which has solenoid coil or screw connections.
- Covers 99% of injectors.

QTY: 2 SETS
G.W: 14.5 KGS
MEAS: 39x23.5x29.5 CM

717604



90 PCS DRILL TOOL SET

21pcs Twist drill bits : 1.5*3/2*4/2.5*4/
3/3.2/3.5/4/4.5/4.8/5/5.5/6/6.5mm QTY: 6SETS/CTN
GW: 10KGS
14pcs Masonry drill bits:3*3/4*4/5*2/
6*3/8*2/mm MEAS: 42x27.5x25.5CM
5pcs Wood drill bits: 3, 4, 5, 6, 8MM
30pcs 25MM SCREWDRIVER BIT:
7PC SLOTTED: 3, 3, 4, 4, 5, 5, 6MM
8PC PHILLIPS: #1X3, #2X3, #3x2
8PC POZI: #1X3, #2X3, #3x2
4PC STAR: T15 T20 T25 T30
3PC ROBERTSON:S1, S2, S3
10--50MMSCREWDRIVERbits
3PC SLOTTED: 4, 5, 6MM
3PC PHILLIPS: #1, #2, #3
4PC POZI: #1, #2x2, #3
3pcs FLAT WOOD BITS: 13,16,19MM
1pc MAGNETIC HOLDER
1pc COUNTER SINK
1pc ADAPTER
4pcs HOLE SAWS :32 38 44 54MM

717605



110 PCS DRILL TOOL SET

1x magnetic extension bar
2x positioner
10x socket bits
25x drill
50x bits
1x bit holder
13x long bits
3x flat drill
1x measure tape 3M
3x drill bits
1x plastic box

QTY:10SETS/CTN
GW:17KGS
MEAS:58X31.5X22.5CM

717606



128PCS DRILL TOOL SET

11pcs twist drill bits-HSS 4241 with titanium coated :
1.5, 2, 2.5, 3, 3.5, 4, 4.5, 5, 5.5, 6, 6.5mm
5pcs wood drill bits: 4, 5, 6, 8, 10mm
5pcs masonry drill bits : 4, 5, 6, 8, 10mm
3pcs wood spade bits: 13, 16, 19mm
20pcs 25mm screwdriver bits
crv-6150 :
3pc slotted: 4-5-6mm
5pc phillips: #1*2, #2*2, #3
5pc pozi: #1*2, #2*2, #3
3pc square S1, S2, S3.
4pc star: T15, T20, T25, T30.
*12pcs 50mm screwdriver bits
crv-6150 :
3pc slotted: 4, 5, 6mm
3pc phillips: #1 #2 #3

3pc pozi: #1 #2 #3
3pc star: T15, T20, T25.
*9pcs nutdriver, 40cr: 5, 6, 7, 8, 9, 10,11, 12, 13mm
*1pcs bit holder
*1pc counter sink
*1pc plastic ruler
*60pcs wall plugs:5mm, 6mm, 8mm, 10mm
1pc blow case

QTY:8SETS/CTN
GW:11.6KGS
MEAS:56X26X24.5MM



717104



96 PCS TOOL SET

- 1pc scissors
- 2pcs screwdrivers
- 1pc 6" long nose pliers
- 40pcs small nails in a plastic box
- 1pc bit holder
- 1pc hammer
- 1pc knife
- 1pc level
- 1pc measure tape 3.5M
- 8pcs hex key wrench
- 20pcs bits
- 9pcs 1/4" socket
- 4pcs precision screwdriver
- 5pcs blade
- 1pc blow case

MEAS: 57 X 35 X 30 CM
 QTY: 6 SETS
 G.W: 15 KGS

717105



85 PCS TOOL SET

- 20pcs bits
- 6pcs precision screwdriver
- 40pcs small nails in a plastic box
- 1pc level
- 1pc measure tape 3M
- 1pc knife
- 1pc claw hammer
- 1pc bit holder
- 1pc 6" adjustable wrench
- 1pc scissors
- 1pc 6" diagonal cutting pliers
- 1pc 6" long nose pliers
- 8pcs hex key wrench
- 1pc locking pliers
- 1pc blow case

MEAS: 50 X 36 X 29 CM
 QTY: 6 SETS
 G.W: 15 KGS

717210

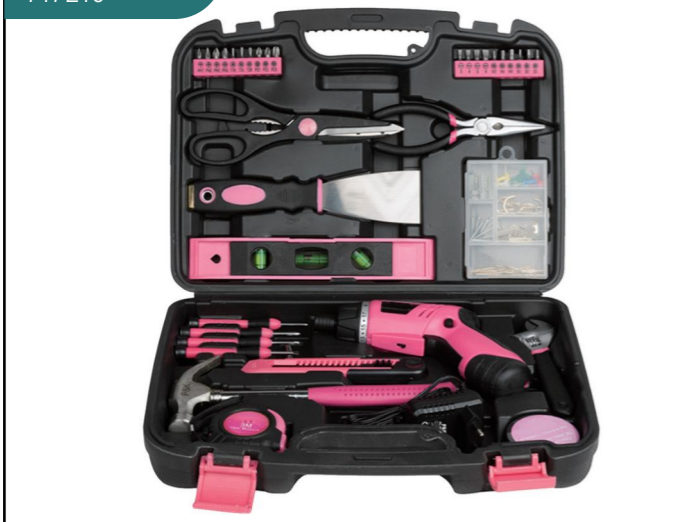

119 PCS TOOL SET

- 20pcs bits
- 1pc scissors
- 1pc long nose pliers
- 1pc putty knife
- 1pc level
- 90pcs fasteners
- 4pcs precision screwdriver
- 1pc electric screwdriver
- 1pc charger
- 1pc 6" adjustable wrench
- 1pc knife
- 1pc claw hammer
- 1pc measure tape 3M
- 1pc PVC tape
- 1 pc extension bar

QTY:5PCS/CTN
 GW:15 KGS
 MEAS:49.5X38.5X29.5CM

717211



97 PCS TOOL SET

- 1pc level
- 1pc 4.5long nose plier
- 1pc 4.5diagonal cutting plier
- 1pc knife
- 5pcs blades
- 1pc adjustable wrench
- 2pcs precision screwdrivers
- 1pc bit driver handle
- 1pc 8oz claw hammer
- 1pc tool bag
- 1pc measure tape 3m
- 1pc putty knife
- 20pcs bits
- 60pcs assortment fasteners in a plastic bag

QTY:12 SETS/CTN
 GW.:18 KGS
 MEAS:36X27X21CM

717402



36 PCS TOOL SET

- 1pc long nose plier 6'
- 1pc diagonal plier6'
- 20pcs bits
- 1pc 6'adjustable plier
- 1pc level
- 1pc bit driver handle
- 1pc min-hammer
- 8pc hex key
- 1pc knife
- 1pc tool bag

QTY:20SETS/CTN
 GW:21KGS
 MEAS:59X29.5X35CM

717401



138 PCS TOOL SET

- 2pcs Precision screwdriver
- 1pc bit handle
- 20pcs bits set
- 1pc 200g hammer
- 1pc level
- 8pcs hex key
- 1pc 3m measure tape
- 1pc 6' combination plier
- 1pc 6'long nose plier
- 1pc 6' adjustable wrench
- 100pcs hardware
- 1pc tool bag

QTY: 10SETS/CTN
 G.W : 15KGS
 MEAS : 54X35.5X47CM

717601



25 PCS GARDEN TOOL SET

- 3pcs Gardening three-piece set
- 1pc gin
- 1pc shovel
- 1pc cable tie
- 1pc 8'Garden shears
- 1pc Bamboo basket
- 4pcs Plug to brand
- 10pcs The label
- 1pc Succulent growing kit
- 1pc Garden kneeler
- 1pc tool bag

QTY:6SETS/CTN
 GW:11KGS
 MEAS:47x36.5x44CM

717602



28 PCS DOG TOY TOOL SET

- 1pc Pooper scoopers
- 15pcs Garbage bags
- 1pc tractor
- 1pc Double knot rope
- 1pc frisbee
- 1pc Throwing tennis
- 1pc Nail clippers
- 1pc file
- 1pc Cosmetic brush
- 1pc The flea comb
- 1pc Open comb
- 1pc Single comb
- 1pc Tun hair comb
- 1pc bag

QTY:8SETS/CTN
 GW:9.8KGS
 MEAS:35X32.5X60CM

717603



10 PCS HORSE TOOL SET

- 1pc flat back oval PP silk
- 1pc rounded corner middle comb
- 1pc knife-edge horse hooks
- 1pc 7 inch tip brush PP silk
- 1pc horse wiper with round handle
- 1pc flat turtle set
- 1pc large plastic brush
- 1pc sponge
- 1pc horse set pink kit
- 1pc tool bag

QTY:8SETS/CTN
 GW:15.5KGS
 MEAS:55.2X35.3X49.5CM



CORDLESS DRILL



Optional with impact function

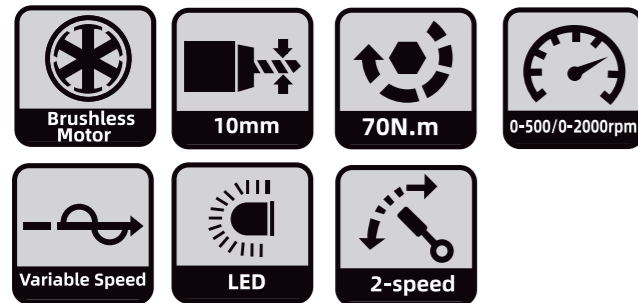

920013

920014

920015

920016

FEATURE CE

- High torque high-speed brushless motor
- Laser engraving adhesive handle
- Super bright LED work light
- High speed and low speed working mode
- 16V high capacity lithium battery
- Industrial grade metal self-locking chuck

Model	920013	920014	920015	920016
Motor Type	Brushless(4812#)			
Rated Voltage	DC16V Li-ion			
No-Load Speed	0-400/0-1350 RPM			
Max. Torque	70 N.m			
Impact Frequency	N/A	0-25000 BPM	N/A	0-25000 BPM
Torque Ranging Setting	20+1	20+1+1+1	20+1	20+1+1+1
Chuck Spec.	Φ10mm		Φ13mm	
Battery Capacity	1500 & 2000 mAh			
Switch Type	Stepless			
LED Work Light	Yes			
Shaft Lock	Yes			

CORDLESS IMPACT SCREWDRIVER

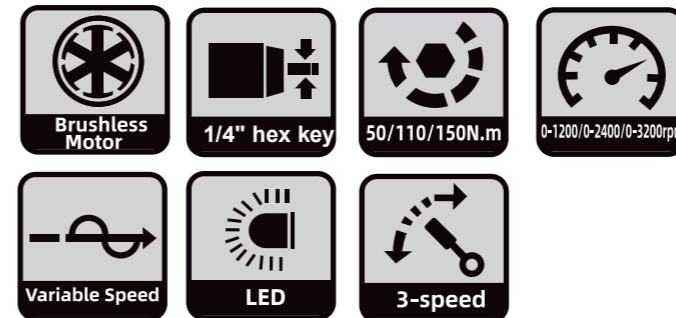

920017

FEATURE CE

- High torque high-speed brushless motor
- Laser engraving adhesive handle
- Super bright LED work light
- Three speed regulation working mode
- 16V high capacity lithium battery
- Industrial level strike team

Model	920017
Motor Type	Brushless(4812#)
Rated Voltage	DC16V Li-ion
No-Load Speed	0-1100/2000/2800 RPM
Impact Frequency	0-1500/0-3300/0-3800 BPM
Max. Torque	50/110/150 N.m
Chuck Spec.	6.35mm(1/4 inch) Hex key
Battery Capacity	1500 & 2000 mAh
Switch Type	Stepless
LED Work Light	Yes

CORDLESS IMPACT DRILL

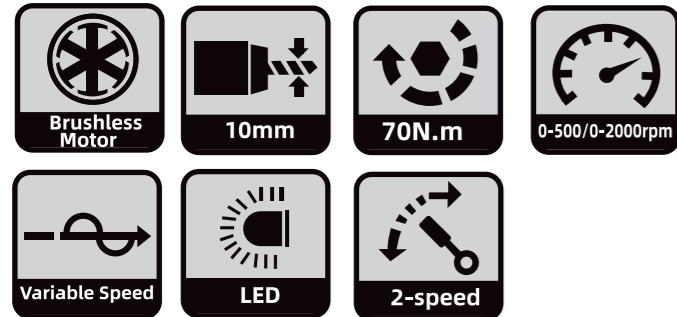

- 920030
- 920031
- 920032
- 920033



FEATURE CE

- High torque high-speed brushless motor
- Laser engraving adhesive handle
- Super bright LED work light
- High speed and low speed working mode
- 21V high capacity lithium battery
- Industrial grade metal self-locking chuck

Model	920030	920031	920032	920033
Specifications				
Motor Type	Brushless(4815#)			
Rated Voltage	DC21V Li-ion			
No-Load Speed	0-500/0-1800 RPM			
Max. Torque	70N.m			
Impact Frequency	N/A	0-26000 BPM	N/A	0-26000 BPM
Torque Ranging Setting	20+1	20+1+1+1	20+1	20+1+1+1
Chuck Spec.	Φ10mm		Φ13mm	
Battery Capacity	2000 & 4000 mAh			
Switch Type	Stepless			
LED Work Light	Yes			
Shaft Lock	Yes			

CORDLESS IMPACT DRILL

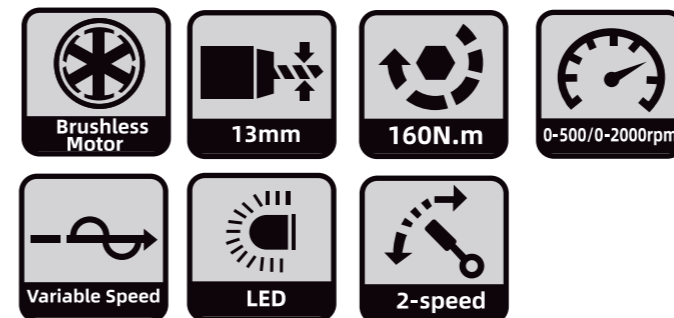

- 920034
- 920035
- 920036
- 920037



FEATURE CE

- High torque high-speed brushless motor
- Laser engraving adhesive handle
- Super bright LED work light
- High speed and low speed working mode
- 21V high capacity lithium battery
- Industrial grade metal self-locking chuck

Model	920034	920035	920036	920037
Specifications				
Motor Type	Brushless(4815#)			
Rated Voltage	DC21V Li-ion			
No-Load Speed	0-500/0-1800 RPM			
Max. Torque	90N.m			
Impact Frequency	N/A	0-26000 BPM	N/A	0-26000 BPM
Torque Ranging Setting	20+1	20+1+1+1	20+1	20+1+1+1
Chuck Spec.	Φ10mm		Φ13mm	
Battery Capacity	2000 & 4000 mAh			
Switch Type	Stepless			
LED Work Light	Yes			
Shaft Lock	Yes			

CORDLESS IMPACT DRILL



920038

- Brushless Motor
- 13mm
- 160N.m
- 0-500/0-2000rpm
- Variable Speed
- LED
- 2-speed

FEATURE CE

- High torque high-speed brushless motor
- Laser engraving adhesive handle
- Super bright LED work light
- High speed and low speed working mode
- 21V high capacity lithium battery
- Industrial grade metal self-locking chuck

Model	920038
Specifications	
Motor Type	Brushless(5225#)
Rated Voltage	DC21V Li-ion
No-Load Speed	0-500/0-1800 RPM
Impact Frequency	0-26000 BPM
Max. Torque	160 N.m
Torque Ranging Setting	20+1+1+1
Chuck Spec.	Φ13 mm
Battery Capacity	2000 & 4000 mAh
Switch Type	Stepless
LED Work Light	Yes
Shaft Lock	Yes

CORDLESS IMPACT SCREWDRIVER



920051

- Brushless Motor
- 1/4" hex key
- 100/180/230N.m
- 1800/2600/3300rpm
- Variable Speed
- LED
- 3-speed

FEATURE CE

- High torque high-speed brushless motor
- Laser engraving adhesive handle
- Super bright LED work light
- Three speed regulation working mode
- 21V high capacity lithium battery
- Industrial level strike team

Model	920051
Specifications	
Motor Type	Brushless(4812#)
Rated Voltage	DC21V Li-ion
No-Load Speed	1600/2200/2800 RPM
Impact Frequency	0-2300/0-3600/0-4500 BPM
Max. Torque	100/180/230 N.m
Chuck Spec.	6.35mm(1/4 inch) Hex key
Battery Capacity	2000 & 4000 mAh
Switch Type	Stepless
LED Work Light	Yes

CORDLESS IMPACT WRENCH

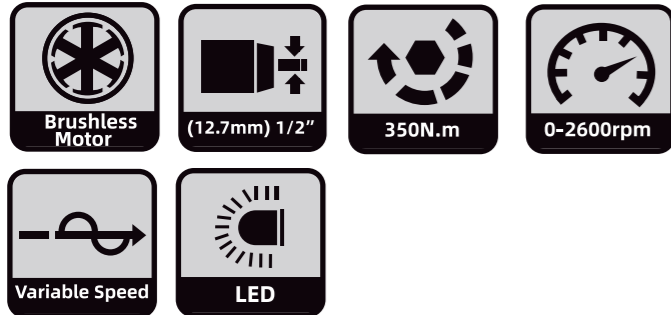

920111

FEATURE CE

- High torque high-speed brushless motor
- Laser engraving adhesive handle
- Super bright LED work light
- Reverse auto stop mode
- 21V high capacity lithium battery
- Industrial level strike team

Model	920111
Specifications	
Motor Type	Brushless(4812#)
Rated Voltage	DC21V Li-ion
No-Load Speed	0-2600 RPM
Impact Frequency	0-3300 BPM
Max. Torque	350 N.m
Chuck Spec.	12.75mm(1/2 inch) Square Shaft
Battery Capacity	2000 & 4000 mAh
Switch Type	Stepless
LED Work Light	Yes

CORDLESS IMPACT WRENCH

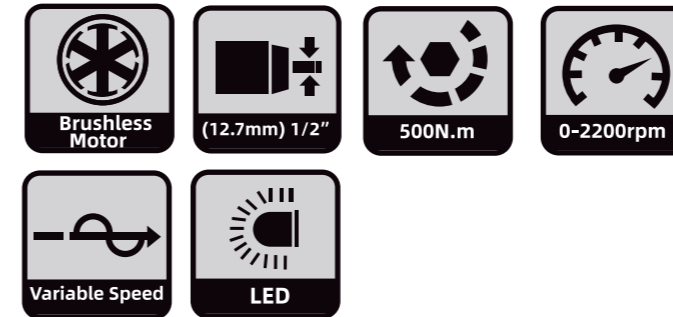

920112

FEATURE CE

- High torque high-speed brushless motor
- Laser engraving adhesive handle
- Super bright LED work light
- Reverse auto stop mode
- 21V high capacity lithium battery
- Industrial level strike team

Model	920112
Specifications	
Motor Type	Brushless(4815#)
Rated Voltage	DC21V Li-ion
No-Load Speed	0-2200 RPM
Impact Frequency	0-3600 BPM
Max. Torque	500 N.m
Chuck Spec.	12.75mm(1/2 inch) Square Shaft
Battery Capacity	2000 & 4000 mAh
Switch Type	Stepless
LED Work Light	Yes

CORDLESS IMPACT WRENCH

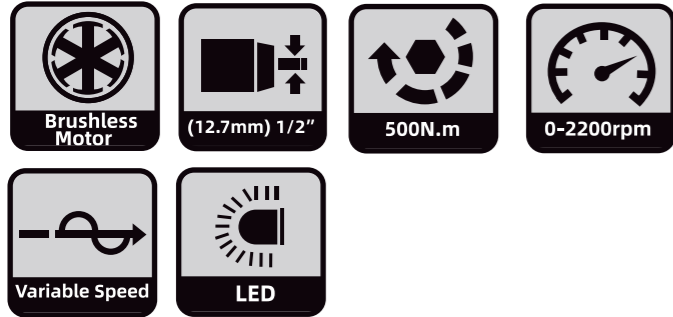

FEATURE CE

- High torque high-speed brushless motor
- Laser engraving adhesive handle
- Super bright LED work light
- Reverse auto stop mode
- 21V high capacity lithium battery
- Industrial level strike team



920113

Model	920113
Spegifications	
Motor Type	Brushless(5225#)
Rated Voltage	DC21V Li-ion
No-Load Speed	0-1500/0-1300/0-2200 RPM
Impact Frequency	0-2400 BPM
Max. Torque	1000N.m
Chuck Spec.	19mm(3/4 inch)/ Square Shaft
Battery Capacity	4000 & 6000 mAh
Switch Type	Stepless
LED Work Light	Yes

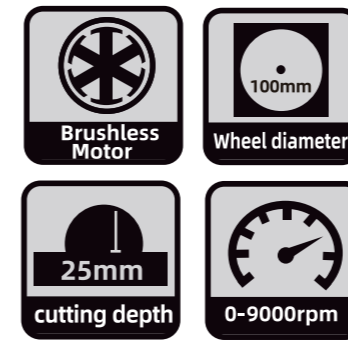

FEATURE CE

- High torque high-speed brushless motor
- Laser engraving adhesive handle
- 21V high capacity lithium battery
- Fully sealed adhesive control smart board effectively prevents dust and water
- Slim handles are more suitable for one handed operation

CORDLESS ANGLEGRINDER



920215

920216

Model	920215	920216
Spegifications		
Motor Type	Brushless(5025#)	
Rated Voltage	DC21V Li-ion	
No-Load Speed	0-5000/0-6500/0-8500 RPM	
Cutting Depth	0-25 mm	
Wheel Diameter	Φ100 mm	Φ125mm
Output Shaft Thread	M10 mm	M14 mm
Battery Capacity	2000 & 4000 mAh	
Switch Type	Anti Self-Locking	
Soft start	Yes	
Power-Off Protection	Yes	
Auxiliary handle	Yes	

CORDLESS MINI CHAINSAW

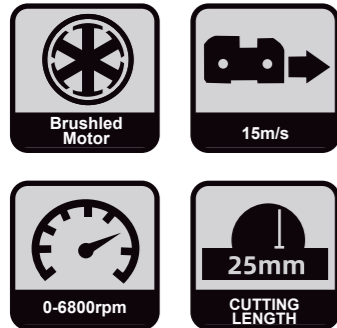

927105

FEATURE CE

- Automatic oil pump
- Chinese chain and bar brand
- Soft grip handle
- Toolless chain tension

Model	927105
Specifications	
Motor Type	Brushless motor
Rated Voltage	DC21V Li-ion
No-Load Speed	3200 RPM
Chain speed	6-8m/s
Chain/bar length	150mm(6 inch)
Oil tank capacity	18ml
Automatic oil pump	Yes
Toolless chain tension	Yes

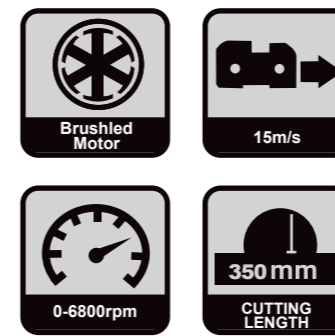

CORDLESS CHAINSAW



927121

FEATURE CE

- Lock off button for safety operation
- Automatic oil lubrication with window to gauge oil level
- Soft start
- Overload display

Model	927121
Specifications	
Motor Type	Brushless motor
Rated Voltage	DC42V Li-ion (21V x 2)
No-Load Speed	6800 RPM
Chain speed	15m/s
Chain/bar length	400mm/16 (inch)
Chain brake activates	≤0.15 seconds
Switch Type	Anti Self-Locking
SDS system	Yes
Automatic oil system	Yes

16V CORDLESS RATCHET WRENCH

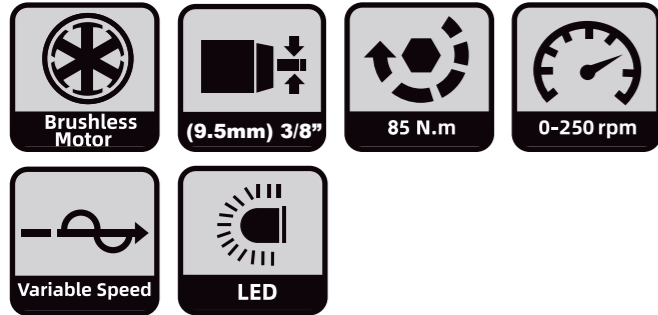

FEATURE CE

- High torque high-speed brushless motor
- Laser engraving adhesive handle
- Super bright LED work light
- Reverse auto stop mode
- 16V high capacity lithium battery
- Industrial level strike team



920018

Model	920018
Specifications	
Motor Type	Brushless(4812#)
Rated Voltage	DC16V Li-ion
No-Load Speed	0-250rpm
Max output Torque	85N·m
Chuck Spec.	9.5mm(3/8 inch) Square Shaft
Handle length	7cm
Switch Type	Stepless
LED Work Light	Yes
Quickly Stop	Yes
Forward & Reverse Function	Yes
Soft grip handle	Yes
Battery capacity	2000mAh x 2PCS
Input	AC220-240V ~ 50Hz,65W
Output	DC16.8V==2000mA
Charging Indicator Light	Yes

16V CORDLESS RATCHET WRENCH

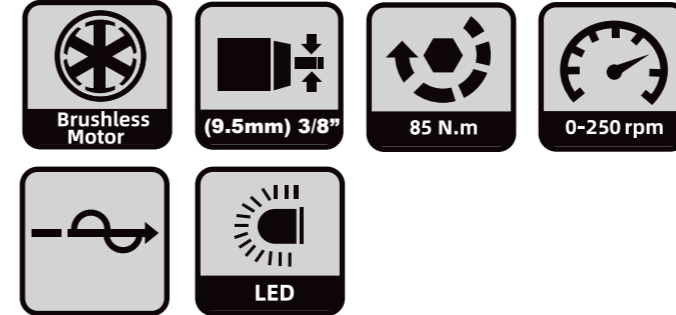

FEATURE CE

- High torque high-speed brushless motor
- Laser engraving adhesive handle
- Super bright LED work light
- Reverse auto stop mode
- 16V high capacity lithium battery
- Industrial level strike team



920019

Model	920019
Specifications	
Motor Type	Brushless(4812#)
Rated Voltage	DC16V Li-ion
No-Load Speed	0-250rpm
Max output Torque	85N·m
Chuck Spec.	9.5mm(3/8 inch) Square Shaft
Handle length	17cm
Switch Type	Stepless
LED Work Light	Yes
Quickly Stop	Yes
Forward & Reverse Function	Yes
Soft grip handle	Yes
Battery capacity	2000mAh x 2PCS
Input	AC220-240V ~ 50Hz,65W
Output	DC16.8V==2000mA
Charging Indicator Light	Yes

21V CORDLESS HAMMER

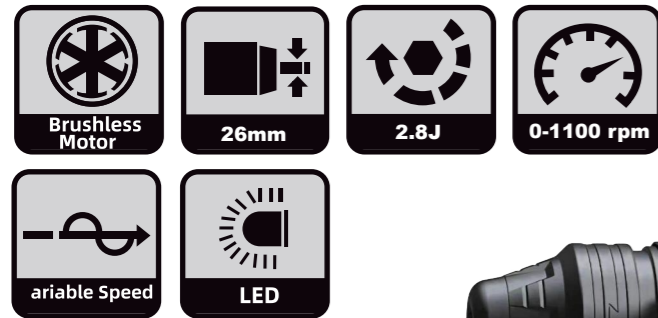

920132

FEATURE CE

- High torque high-speed brushless motor
- Laser engraving adhesive handle
- Super bright LED work light
- Reverse auto stop mode
- 21V high capacity lithium battery
- Industrial level strike team

Model	920132		
Specifications			
Motor Type	Brushless(5025#)		
Rated Voltage	DC21V Li-ion		
No-Load Speed	0-1100 rpm		
Impact times	0-5300 bpm		
Impact Energy	2.8J		
4-function adjustment	Drill /hammer& drill /conversion /hammer		
Max hole-opening	Concrete	Steel	Wood
	26mm	13mm	30mm
Battery capacity	2PCS 4000mAh		
Input	AC220-240V ~ 50Hz,65W		
Output	DC21.5V==2400mA		
Charging Indicator Light	Yes		

21V CORDLESS GRASS TRIMMER

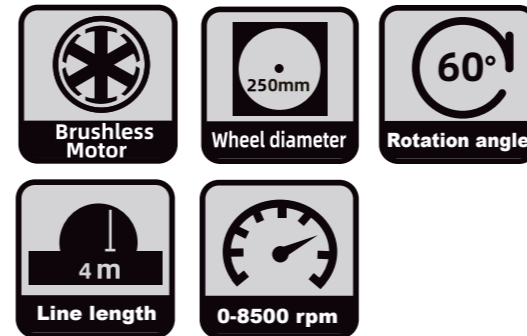

927521

FEATURE CE

- High torque high-speed brushless motor
- Laser engraving adhesive handle
- 21V high capacity lithium battery
- Fully sealed adhesive control smart board effectively prevents dust and water
- Slim handles are more suitable for one handed operation

Model	927521
Specifications	
Motor Type	Brushless motor(4815#)
Rated Voltage	DC 21V Li-ion
No-Load Speed	8500/min
Cutting width	Φ250mm
Wire diameter	Φ1.2mm
Line length	2 x 4m
Telescopic tube	Aluminium
Adjustable auxiliary handle	Yes
Telescopic shaft	Yes
Adjustable work head angle	0°- 60°
Soft grip handle	Yes
Battery capacity	2PCS 2000mAh
Input	AC220-240V ~ 50Hz,65W
Output	DC21.5V==2400mA
Charging Indicator Light	Yes

CORDLESS MINI CHAINSAW

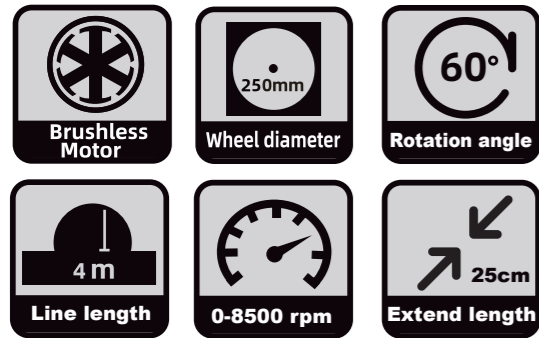

927522

FEATURE CE

- Automatic oil pump
- Chinese chain and bar brand
- Soft grip handle
- Toolless chain tension

Model	927522
Specifications	
Motor Type	Brushless motor(4815#)
Rated Voltage	DC 21V Li-ion
No-Load Speed	8500/min
Cutting width	Φ250mm
Wire diameter	Φ1.2mm
Line length	2 x 4m
Telescopic tube	Aluminium
Telescopic length	25cm
Adjustable auxiliary handle	Yes
Telescopic shaft	Yes
Adjustable work head angle	0°- 60°
Soft grip handle	Yes
Battery capacity	2PCS 2000mAh
Input	AC220-240V ~ 50Hz,65W
Output	DC21.5V==2400mA
Charging Indicator Light	Yes

21V CORDLESS MIXER

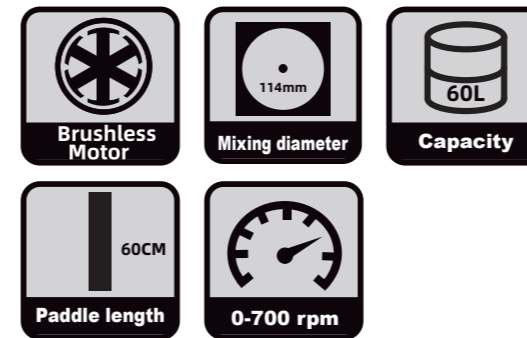

921222

FEATURE CE

- High torque high-speed brushless motor
- Laser engraving adhesive handle
- 21V high capacity lithium battery
- Fully sealed adhesive control smart board effectively prevents dust and water
- Slim handles are more suitable for one handed operation

Model	921222	
Specifications		
Motor Type	Brushless motor(4825#)	
Rated Voltage	DC 21V Li-ion	
No-Load Speed	0-700RPM	
Connection	M14	
Max. Mixing Paddle Dia.	Φ114mm	
Mixing Paddle length	60CM	
Max Capacity	60L	
Soft grip handle	Yes	
Switch Type	Anti Self-Locking	
Soft grip handle	Yes	
Battery capacity	1PC 2000mAh	1PC 4000mAh
Input	AC220-240V ~ 50Hz,65W	
Output	DC21.5V==2400mA	
Charging Indicator Light	Yes	

42V CORDLESS LEAF BLOWER



FEATURE CE

- High torque high-speed brushless motor
- Laser engraving adhesive handle
- Super bright LED work light
- Reverse auto stop mode
- 42V high capacity lithium battery
- Industrial level strike team



927321

Model	927321
Specifications	
Motor Type	Brushless motor(4820#)
Rated Voltage	DC42V(DC21 x 2)
No-Load Speed	0-25,000 RPM
Max Air Speed	48m/s
Max Volume	520 CFM
Turbo function	Yes
Soft grip handle	Yes
Battery capacity	2PCS 4000mAh
Input	AC220-240V ~ 50Hz,65W
Output	DC21.5V==2400mA
Charging Indicator Light	Yes



Model	926820
Product name	Fast Charger
Input	AC100-240V ~ 50Hz,60W
Output	DC16V==1300mA
Charging Indicator Light	Yes



Model	926821
Product name	Charger
Input	AC100-240V 50-60Hz 65W
Output	DC16.8V==2000mA
Charging Indicator Light	LED



Model	926831
Product name	Fast Charger
Input	AC100-240V ~ 50Hz,60W
Output	DC21V==2000mA
Charging Indicator Light	Yes



Model	926835
Product name	Charger
Input	220-240V 50-60Hz 65W
Output	DC21V==2400mA
Charging Indicator Light	Yes



Model	926839
Product name	Charger
Input	AC220-240V 50-60Hz 140W
Output	DC21V==2000mA Total 2 outputs
Charging Indicator Light	Yes



Model	926710	926711
Product name	16V Battery Pack	
Cell no	INR18650(DC3.7V Li-ion)	
Cell capacity	1500mAh	2000mAh
Battery capacity	1500mAh	2000mAh
Cell qty	4PCS	
Battery indicator light	Without	



Model	926712	926713
Product name	16V Battery Pack	
Cell no	INR18650(DC3.7V Li-ion)	
Cell capacity	1500mAh	2000mAh
Battery capacity	1500mAh	2000mAh
Cell qty	4PCS	
Battery indicator light	Without	



Model	926725	
Product name	21V Battery Pack	
Cell no	INR18650(DC3.7V Li-ion)	
Cell capacity	2000mAh	
Battery capacity	2000mAh	
Cell qty	5PCS	
Battery indicator light	Yes	



Model	926733	
Product name	21V Battery Pack	
Cell no	INR18650(DC3.7V Li-ion)	
Cell capacity	2000mAh	
Battery capacity	4000mAh	
Cell qty	10PCS	
Battery indicator light	Yes	



Model	926726	
Product name	21V Battery Pack	
Cell no	INR18650(DC3.7V Li-ion)	
Cell capacity	2000mAh	
Battery capacity	2000mAh	
Cell qty	5PCS	
Battery indicator light	Yes	



Model	926734	
Product name	21V Battery Pack	
Cell no	INR18650(DC3.7V Li-ion)	
Cell capacity	2000mAh	
Battery capacity	4000mAh	
Cell qty	10PCS	
Battery indicator light	Yes	



Model	926744	
Product name	21V Battery Pack	
Cell no	INR18650(DC3.7V Li-ion)	
Cell capacity	2000mAh	
Battery capacity	6000mAh	
Cell qty	15PCS	
Battery indicator light	Yes	



Model	926748	
Product name	21V Battery Pack	
Cell no	INR21700(DC3.7V Li-ion)	
Cell capacity	4000mAh	
Battery capacity	8000mAh	
Cell qty	10PCS	
Battery indicator light	Yes	



Model	926723	926724
Product name	21V Battery Pack	
Cell no	INR18650(DC3.7VLi-ion)	
Cell capacity	1500mAh	2000mAh
Battery capacity	1500mAh	2000mAh
Cell qty	5PCS	5PCS
Battery indicator light	Yes (both sides)	



Model	926729	926732
Product name	21V Battery Pack	
Cell no	INR18650(DC3.7VLi-ion)	
Cell capacity	1500mAh	2000mAh
Battery capacity	3000mAh	4000mAh
Cell qty	10PCS	10PCS
Battery indicator light	Yes (both sides)	



Model	926741	
Product name	21V Battery Pack	
Cell no	INR18650(DC3.7V Li-ion)	
Cell capacity	2000mAh	
Battery capacity	6000mAh	
Cell qty	15PCS	
Battery indicator light	Yes (both sides)	

50+ Cordless Powertools

SHARE
+NE-21V

